

Ultrasonic Flowmeter for Liquids



FLUXUS F601



FLUXUS F608

FLUXUS is a registered trademark of FLEXIM GmbH.

FLEXIM GmbH
Wolfener Strasse 36
12681 Berlin
Germany

Tel.: +49 (30) 936 67 660
Fax: +49 (30) 936 67 680
E-mail: flexim@flexim.de
www.flexim.com

User manual for
FLUXUS F60x
UMFLUXUS_F6V4-5-1EN, 2016-05-11
Copyright (©) FLEXIM GmbH 2016
Subject to change without notification.

The language of the transmitter display can be set (see section 10.5).

The transmitter can be operated in the language of your choice (see section 10.5).

Il est possible de sélectionner la langue utilisée par le transmetteur à l'écran (voir section 10.5).

El caudalímetro puede ser manejado en el idioma de su elección (ver sección 10.5).

De transmitter kan worden gebruikt in de taal van uw keuze (zie gedeelte 10.5).

Имеется возможность выбора языка информации, отображаемой на экране преобразователя (смотри подраздел 10.5).

Table of Contents

1	Introduction	9
1.1	Regarding this Manual	9
1.2	Safety Instructions	9
1.3	Warranty	10
2	Handling	11
2.1	First Inspection	11
2.2	General Precautions	11
2.3	Cleaning	11
2.4	Storage	12
3	General Principles	13
3.1	Measurement System	13
3.2	Measurement Principle	13
3.3	Measurement Arrangements	18
4	Description of the Transmitter	21
4.1	Design	21
4.2	Status Indication	22
4.3	Keyboard	22
5	Selection of the Measuring Point	24
5.1	Acoustic Penetration	24
5.2	Undisturbed Flow Profile	26
5.3	Selection of the Measurement Arrangement Taking into Account the Measuring Range and the Measuring Conditions	29
5.4	Selection of the Sound Beam Plane near an Elbow	30
6	Installation of FLUXUS F601	31
6.1	Location	31
6.2	Installation of the Transmitter	31
6.3	Connection of the Transducers	33
6.4	Power Supply	34
6.5	Connection of the Outputs	36
6.6	Connection of the Inputs	38
6.7	Connection of the Serial Interface	44
7	Installation of FLUXUS F608	45
7.1	Location	45
7.2	Installation of the Transmitter	45
7.3	Connection of the Transducers	47
7.4	Power Supply	49
7.5	Connection of the Outputs (FLUXUS F608**-A2, Optional)	55
7.6	Connection of the Inputs (Optional)	57
7.7	Connection of the Serial Interface	60

8	Mounting of the Transducers	62
8.1	Preparation of the Pipe	62
8.2	Orientation	62
8.3	Fixing the Transducer Cables	63
8.4	Installation of the Transducers with Fastening Shoes and Chains	63
8.5	Installation the Transducers with Magnetic Fastening Shoes	64
8.6	Installation of the Transducers with Portable Variofix Rail with Chains	65
9	Installation of the Temperature Probe (Optional)	67
9.1	Preparation of the Pipe	67
9.2	Installation of the Temperature Probe (Response Time 50 s)	67
9.3	Installation of the Temperature Probe (Response Time 8 s)	69
9.4	Connection of the Temperature Probe	70
10	Start-Up of the Transmitter	73
10.1	Switching on/off	73
10.2	Initialization	73
10.3	Display	74
10.4	HotCodes	76
10.5	Language Selection	77
11	Basic Measurement	78
11.1	Input of the Pipe Parameters	78
11.2	Input of the Fluid Parameters	81
11.3	Other Parameters	83
11.4	Selection of the Channels	83
11.5	Defining the Number of Sound Paths	84
11.6	Transducer Distance	84
11.7	Start of the Measurement	87
11.8	Detection of the Flow Direction	88
11.9	Stopp the Measurement	88
12	Displaying the Measured Values	89
12.1	Selection of the Physical Quantity and of the Unit of Measurement	89
12.2	Toggling between the Channels	90
12.3	Adjustment of the Display	91
12.4	Status Line	92
12.5	Transducer Distance	93
13	Advanced Measuring Functions	94
13.1	Damping Factor	94
13.2	Totalizer	94
13.3	Settings of the HybridTrek Mode	96
13.4	Upper Limit of the Flow Velocity	98
13.5	Cut-Off Flow	99

13.6	Uncorrected Flow Velocity	100
13.7	Measurement of High Dynamic Flows (FastFood Mode)	101
13.8	Calculation Channels	102
13.9	Change of the Limit for the Inner Pipe Diameter	106
13.10	Diagnosis by means of the Snap Function	106
14	Data Logger and Transmission of Data	108
14.1	Data Logger	108
14.2	Transmission of Data	113
15	Working with Parameter Records	121
15.1	Introduction	121
15.2	Storing of a Parameter Record	121
15.3	Loading of a Parameter Record	121
15.4	Deleting Parameter Records	122
16	Libraries	123
16.1	Partitioning of the Coefficient Memory	123
16.2	Input of Material/Fluid Parameters without the Extended Library	125
16.3	Extended Library	127
16.4	Deleting a User Defined Material/Fluids	131
16.5	Arrangement of the Material/Fluid Scroll List	132
17	Settings	134
17.1	Time and Date	134
17.2	Dialogs and Menus	134
17.3	Measurement Settings	138
17.4	Setting the Contrast	140
17.5	Instrument Information	140
18	SuperUser Mode	142
18.1	Activation/Deactivation	142
18.2	Transducer Parameters	142
18.3	Defining the Flow Parameters	143
18.4	Limit of the Signal Amplification	145
18.5	Upper Limit of the Sound Speed	146
18.6	Detection of Long Measurement Failures	147
18.7	Number of Decimal Places of the Totalizers	147
18.8	Temperature-Based Heat Flow Cut-Off	148
18.9	Manual Reset of the Totalizers	149
18.10	Display of the Sum of the Totalizers	149
18.11	Display of the Last Valid Measured Value	149
18.12	Display During the Measurement	150
19	Wall Thickness Measurement (optional)	151
19.1	Orientation of the Wall Thickness Probe	151

19.2	Activation of the Wall Thickness Measurement	152
19.3	Parameter Input	152
19.4	Measurement	153
20	Heat Flow Measurement	157
20.1	Calculation of the Heat Flow	158
20.2	Normal Measuring Mode	158
20.3	BTU Mode	161
20.4	Measurement	163
20.5	Two independent Heat Flow Measurements	164
20.6	Steam in Inlet	165
21	Inputs	167
21.1	Assignment of the Temperature Inputs to the Measuring Channels	167
21.2	Selection of the Temperature Probe	168
21.3	Assignment of other Inputs to the Measuring Channels	168
21.4	Activation of the Inputs	169
21.5	Temperature Correction	170
22	Outputs	172
22.1	Installation of an Output	172
22.2	Error Value Delay	178
22.3	Activation of an Analog Output	179
22.4	Configuration of an Output Using the Adapter for the Active Current Input	181
22.5	Configuration of a Frequency Output as a Pulse Output	182
22.6	Activation of a Binary Output as a Pulse Output	183
22.7	Activation of a Binary Output as an Alarm Output	184
22.8	Behavior of the Alarm Outputs	188
22.9	Deactivation of the Outputs	191
23	Troubleshooting	192
23.1	Problems with the Measurement	193
23.2	Selection of the Measuring Point	194
23.3	Maximum Acoustic Contact	194
23.4	Application Specific Problems	194
23.5	Large Deviations of the Measured Values	195
23.6	Problems with the Totalizers	196
23.7	Problems During the Heat Flow Measurement	196
23.8	Transmission of Data	196
A	Menu Structure	197
B	Units of Measurement	223
C	Reference	229
D	Conformity Declarations	234

1 Introduction

1.1 Regarding this Manual

This user manual has been written for the users operating the ultrasonic flowmeter FLUXUS. It contains important information about the measuring instrument, how to handle it correctly, and how to avoid damages.

Attention!	Observe the Safety Instructions for the Use in Explosive Atmosphere (see document SIFLUXUS_608).
-------------------	--

Read the safety Instructions carefully. Make sure you have read and understood this user manual before using the measuring instrument.

Note!	For technical data see Technical Specification.
--------------	---

All reasonable effort has been made to ensure the correctness of the content of this user manual. However, if you find any erroneous information, please inform us. We will be grateful for any suggestions and comments regarding the concept and your experience working with the measuring instrument.

This will ensure that we can further develop our products for the benefit of our customers and in the interest of technological progress. If you have any suggestions about improving the documentation and particularly this user manual, please let us know so that we can consider your comments for future reprints.

The contents of this user manual are subject to changes without prior notice. All rights reserved. No part of this user manual may be reproduced in any form without FLEXIM's written permission.

1.2 Safety Instructions

The user manual contains instructions that are marked as follows:

Note!	This text contains important information about the use of the flowmeter.
--------------	--

Attention!	This text contains important instructions which should be observed to avoid damage or destruction of the measuring instrument. Proceed with special caution!
-------------------	--



	This text contains safety instructions for the use in an explosive atmosphere.
---	--

Observe these safety instruction!

1.3 Warranty

We warrant the reliability of the material and workmanship of FLUXUS for the term specified in the sales contract, provided the measuring instrument is used for the purpose for which it was designed, and operated according to the instructions given in this user manual. Improper use of the FLUXUS leads to the withdrawal of any warranties of any kind, explicit or implicit.

Incorrect use includes:

- replacement of a component of FLUXUS with a component that was not approved by FLEXIM
- unsuitable or insufficient maintenance
- repair of FLUXUS by unauthorized personnel

FLEXIM assumes no responsibility for injuries to the customer or third persons directly caused by material failure due to unpredictable defects in the product or for any indirect damages.

FLUXUS is a very reliable instrument. It is manufactured under strict quality control using modern production techniques. If installed as recommended in an appropriate location, used cautiously and taken care of conscientiously, no troubles should appear.

If any problem appears which cannot be solved with the help of this user manual (see chapter 23), contact our sales office and give a precise description of the problem. Specify the type, serial number and firmware version of the measuring instrument.

2 Handling

2.1 First Inspection

The measuring instrument has tested thoroughly at the factory. At delivery, proceed to a visual control to make sure that no damage has occurred during transportation.

Make sure that the specifications of the delivered measuring instrument correspond to the specifications given on the purchase order.

The type and the serial number of the transmitter are shown on the nameplate. The transducer type is printed on the transducers.

2.2 General Precautions

Attention! Observe the Safety Instructions for the Use in Explosive Atmosphere (see document SIFLUXUS_608).

FLUXUS is a precision measuring instrument and has to be handled with care. In order to obtain good measurement results and not damage the measuring instrument, it is important to pay special attention to the instructions given in this user manual, particularly to the following points:

- Protect the transmitter from shocks.
- Keep the transducers clean. Handle the cables with care. Avoid excessive cable bend.
- Make sure to work under correct ambient and operating temperatures. The ambient temperature at the measuring point has to be within the operating temperature range of the transmitter and the transducers (see Technical Specification (FLUXUS F601) or (FLUXUS F608)).
- Use a correct external power supply when the transmitter is not used with the battery.
- Handle the charging unit and the battery correctly (see section 6.4.1 or section 7.4.1).
- The power supply unit and the battery charger are not protected against moisture. Use them in dry rooms only.
- Observe the degree of protection (see Technical Specifications (FLUXUS F601) or (FLUXUS F608)).

2.3 Cleaning

- Clean the transmitter with a soft cloth. Do not use detergents.
- Remove traces of the coupling compound from the transducers with a soft paper towel.

2.4 Storage

- Wipe the transducers clean of traces of the coupling compound.
- After the measurement, always put the transmitter and its accessories into the corresponding compartments of the transport case.
- Avoid excessive cable bends, especially when closing the cover of the transport case.
- Observe the notes on the storage of the battery (see Storage of the Battery in section 6.4.1 or section 7.4.1).

3 General Principles

For the ultrasonic measurement of the flow rate, the flow velocity of the fluid in a pipe is determined. Further physical quantities (e.g., volumetric flow rate, mass flow rate, heat flow rate) are derived from the flow velocity and from additional physical quantities, if necessary.

3.1 Measurement System

The measurement system consists of a transmitter, the ultrasonic transducers with the transducer cables and the pipe on which the measurement is conducted.

The ultrasonic transducers are mounted on the outside of the pipe. Ultrasonic signals are sent through the fluid and received by the transducers. The transmitter controls the measuring cycle, eliminates the disturbance signals and analyzes the useful signals. The measured values can be displayed, used for calculations and transmitted.

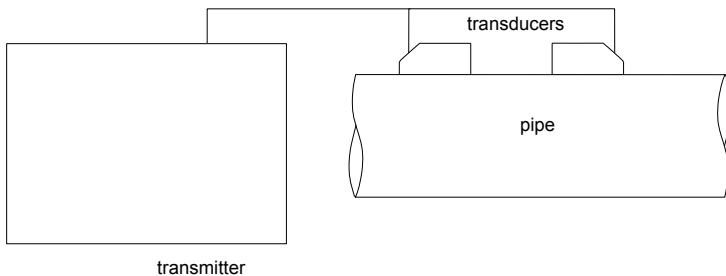

Fig. 3.1: Example of a measurement setup

3.2 Measurement Principle

The flow velocity of the fluid is measured in the TransitTime mode using the ultrasonic-transit time difference correlation principle (see section 3.2.2). If the proportion of gas or solid particles is high, the transmitter can toggle to the NoiseTrek mode (see section 3.2.3).

3.2.1 Terms

Flow profile

Distribution of the flow velocities over the cross-sectional pipe area. For an optimal measurement, the flow profile has to be fully developed and axisymmetrical. The shape of the flow profile depends on whether the flow is laminar or turbulent and is influenced by the conditions in the supply line of the measuring point (see chapter 5).

Reynolds number Re

Coefficient describing the turbulence behavior of a fluid in the pipe. The Reynolds number Re is calculated from the flow velocity, the kinematic viscosity of the fluid and the inner pipe diameter.

If the Reynolds number exceeds a critical value (usually approx. 2 300, if the fluid flows in a pipe), a transition from a laminar flow to a turbulent flow takes place.

Laminar flow

A flow without any turbulence. There is no disruption between the parallel flowing layers of the fluid.

Turbulent flow

A flow in which turbulence (swirling of the fluid) occurs. In technical applications, the flow in the pipe is mostly turbulent.

Transition range

The flow is partly laminar and partly turbulent.

Transit time difference Δt

Difference of the transit times of the signals. In the TransitTime method, the transit time difference of the signals in and against the flow direction is measured, in the NoiseTrek mode - the time difference of the signal from the transducer to the particle and from the particle to the transducer. The flow velocity of the fluid flowing in the pipe is determined from the transit time difference (see Fig. 3.2, Fig. 3.3, Fig. 3.4 and Fig. 3.5).

Sound speed c

Speed of the propagating sound. The sound speed depends on the mechanical properties of the fluid or the pipe material. In pipe materials and other solid materials, a distinction is made between the longitudinal and transversal sound speed. For the sound speed of some fluids and materials see annex C.

Flow velocity v

Average value of all flow velocities of the fluid over the cross-sectional pipe area.

Acoustic calibration factor k_a

$$k_a = \frac{c_\alpha}{\sin \alpha}$$

The acoustic calibration factor k_a is a parameter of the transducer which results from the sound speed c within the transducer and the angle of incidence (see Fig. 3.2). According to Snell's law of refraction, the angle of propagation in the adjoining fluid or pipe material is:

$$k_a = \frac{c_\alpha}{\sin \alpha} = \frac{c_\beta}{\sin \beta} = \frac{c_\gamma}{\sin \gamma}$$

Fluid mechanics correction factor k_{Re}

With the fluid mechanics correction factor k_{Re} , the measured value of the flow velocity in the area of the sound beam is converted into the value of the flow velocity across the whole cross-sectional pipe area. In case of a fully developed flow profile, the fluid mechanics correction factor only depends on the Reynolds number and the roughness of the inner pipe wall. The fluid mechanics correction factor is recalculated by the transmitter for each new measurement.

Volumetric flow rate \dot{V}

$$\dot{V} = v \cdot A$$

The volume of the fluid that passes through the pipe per unit time. The volumetric flow rate is calculated from the product of the flow velocity v and the cross-sectional pipe area A .

Mass flow rate \dot{m}

$$\dot{m} = \dot{V} \cdot \rho$$

The mass of the fluid that passes through the pipe per unit time. The mass flow rate is calculated from the product of the volumetric flow rate \dot{V} and the density ρ .

Heat flow Φ

The heat quantity that is transferred per unit time. For the calculation of the heat flow see chapter 20.

3.2.2 Measurement of the Flow Velocity in the TransitTime Mode

The signals are emitted and received by a transducer pair alternatively in and against the flow direction. If the fluid moves, the signals propagating in the fluid are displaced with the flow. This displacement causes a reduction in distance for the signal in the flow direction and an increase in distance for the signal against the flow direction in the section of the receiving transducer (see Fig. 3.2 and Fig. 3.3). This causes a change in the transit times. The transit time of the signal in the flow direction is shorter than the transit time against the flow direction. This transit time difference is proportional to the average flow velocity.

The average flow velocity of the fluid is calculated as follows:

$$v = k_{Re} \cdot k_a \cdot \frac{\Delta t}{2 \cdot t_{fl}}$$

with

v – average flow velocity of the fluid

k_{Re} – fluid mechanics correction factor

k_a – acoustic calibration factor

Δt – transit time difference

t_{fl} – transit time in fluid

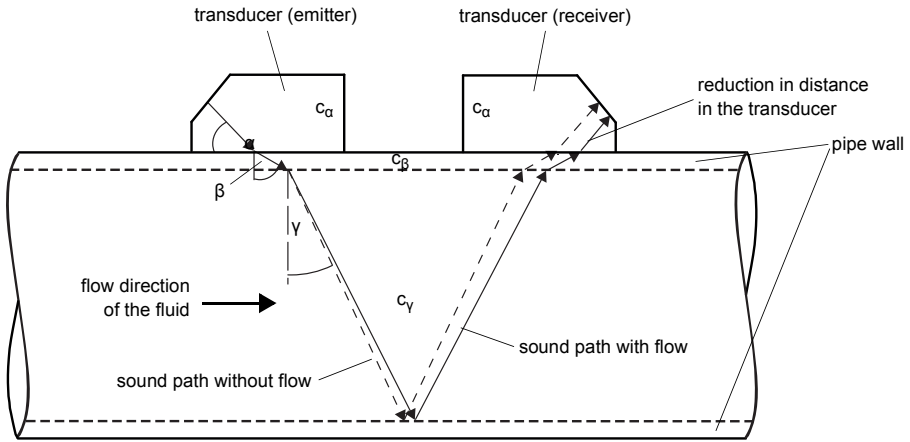

Fig. 3.2: Sound path of the signal in the flow direction

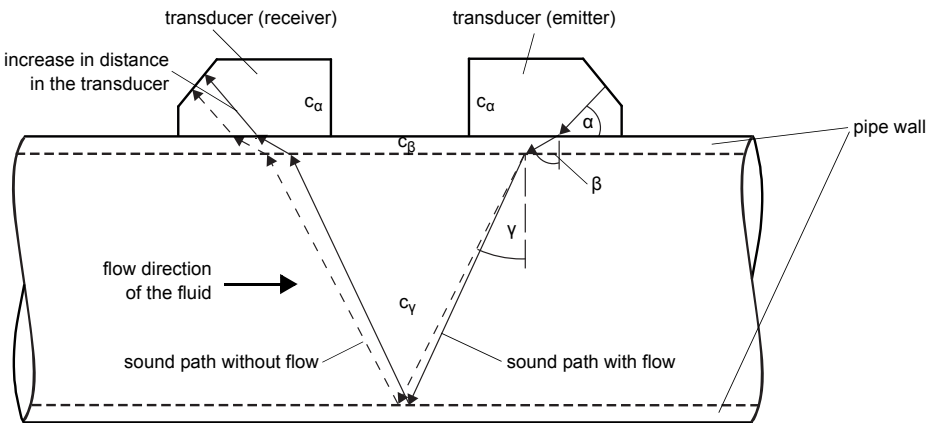

Fig. 3.3: Sound path of the signal against the flow direction

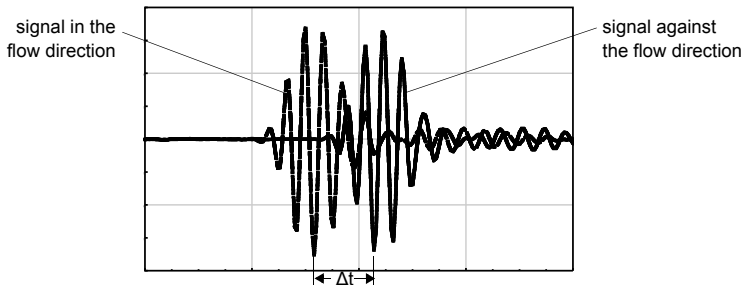

Fig. 3.4: Transit time difference Δt

3.2.3 Measurement of the Flow Velocity in the NoiseTrek Mode

When fluids with a high proportion of gas bubbles or solid particles are measured, the attenuation of the ultrasonic signal increases and can inhibit the propagation of the signal in the fluid. A measurement in the TransitTime mode is not possible anymore.

The NoiseTrek mode uses the presence of gas bubbles and solid particles in the fluid. The measurement setup used in the TransitTime mode does not need to be changed. Ultrasonic signals are sent into the fluid at short intervals, reflected by the gas bubbles or the solids particles and again received by the transducer. The transit time difference between two consecutive measuring signals that are reflected by the same particle is determined. The transit time difference is proportional to the distance covered by the particle in the time between the two measuring signals and therefore to the velocity at which the particle moves through the pipe (see Fig. 3.5).

The average value of all measured velocities of gas bubbles and/or particles corresponds to the flow velocity of the fluid:

$$v = k_{Re} \cdot k_a \cdot \frac{\Delta t}{2 \cdot t_s}$$

with

v – average flow velocity of the fluid

k_{Re} – fluid mechanics correction factor

k_a – acoustic calibration factor

Δt – transit time difference of the measuring signals

t_s – time interval between the measuring signals

Depending on the signal attenuation, the error of measurement in the NoiseTrek mode can be greater than in the TransitTime mode.

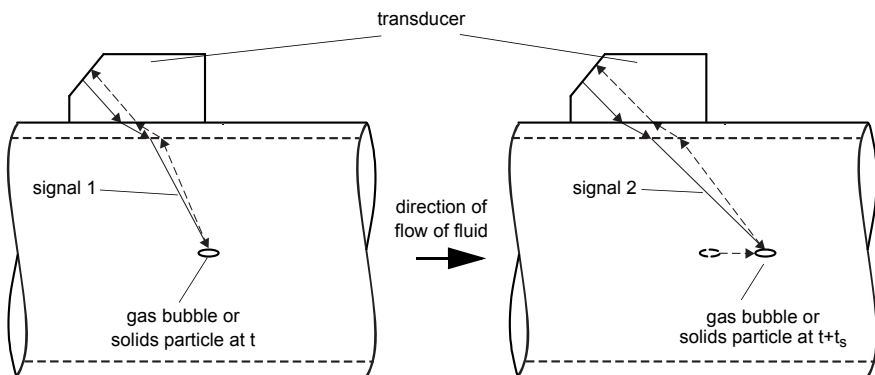

Fig. 3.5: Measurement of the flow velocity in the NoiseTrek mode

3.2.4 HybridTrek Mode

The HybridTrek mode combines the TransitTime mode and the NoiseTrek mode. During a measurement in the HybridTrek mode, the transmitter automatically toggles between the TransitTime mode and the NoiseTrek mode depending on the gaseous or solid content.

3.3 Measurement Arrangements

3.3.1 Terms

Diagonal arrangement

The transducers are mounted on the opposite sides of the pipe (see Fig. 3.6).

Reflection arrangement

The transducers are mounted on the same side of the pipe (see Fig. 3.7).

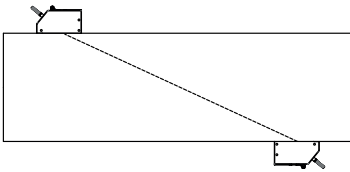

Fig. 3.6: Diagonal arrangement

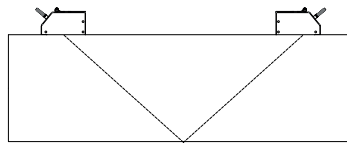

Fig. 3.7: Reflection arrangement

Sound path

The distance covered by the ultrasonic signal after crossing the pipe once. The number of the sound paths is:

- odd if the measurement is conducted in the diagonal arrangement
- even if the measurement is conducted in the reflection arrangement

(see Fig. 3.9 or Fig. 3.8).

Beam

The path covered by the ultrasonic signal between the transducers: the transducer emitting the ultrasonic signal and the transducer receiving it. A beam consists of 1 or several sound paths (see Fig. 3.8 or Fig. 3.9).

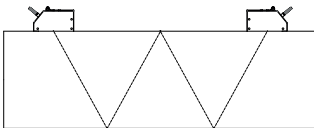

Fig. 3.8: 1 beam, 4 sound paths,
reflection arrangement

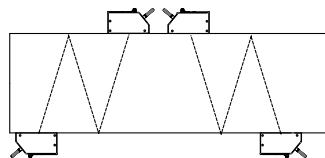
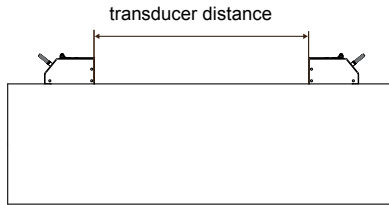

Fig. 3.9: 2 beams, 3 sound paths,
diagonal arrangement

Transducer distance

Distance between the transducers. It is measured between the inner edges of the transducers.

reflection arrangement



diagonal arrangement
(positive transducer distance)

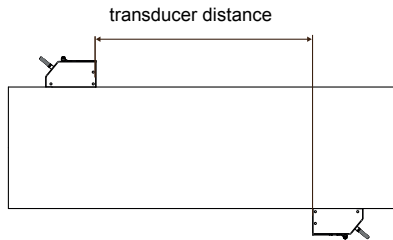

diagonal arrangement
(negative transducer distance)

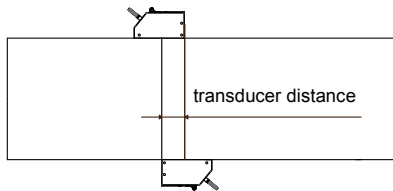

Sound beam plane

The plane containing one, two or more sound paths or beams (see Fig. 3.10).

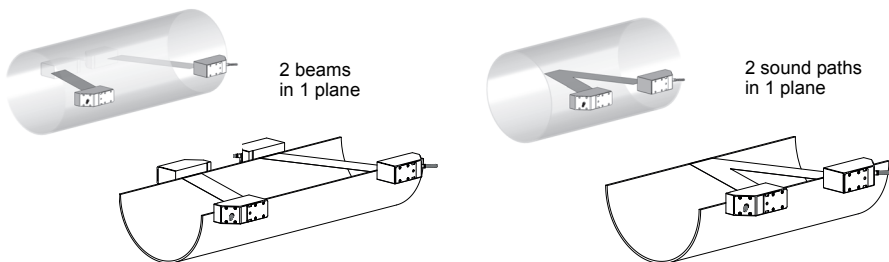
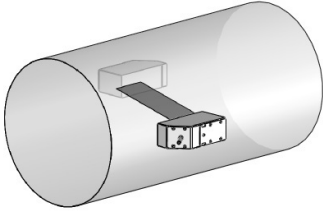
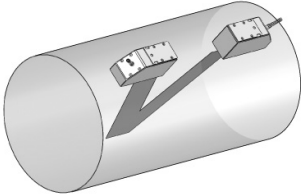
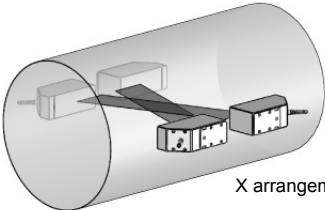
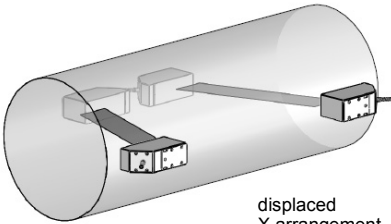
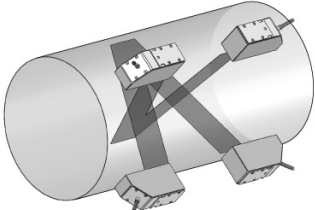

Fig. 3.10: Sound paths and beams in one plane

3.3.2 Examples

diagonal arrangement with 1 beam	reflection arrangement with 1 beam
<p>1 transducer pair 1 sound path 1 beam 1 plane</p> 	<p>1 transducer pair 2 sound paths 1 beam 1 plane</p> 
diagonal arrangement with 2 beam	reflection arrangement with 2 beams and 2 planes
<p>2 transducer pairs 1 sound path 2 beams 1 plane</p>  <p style="text-align: right;">X arrangement</p>  <p style="text-align: right;">displaced X arrangement</p>	<p>2 transducer pairs 2 sound paths 2 beams 2 planes</p> 

4 Description of the Transmitter

4.1 Design

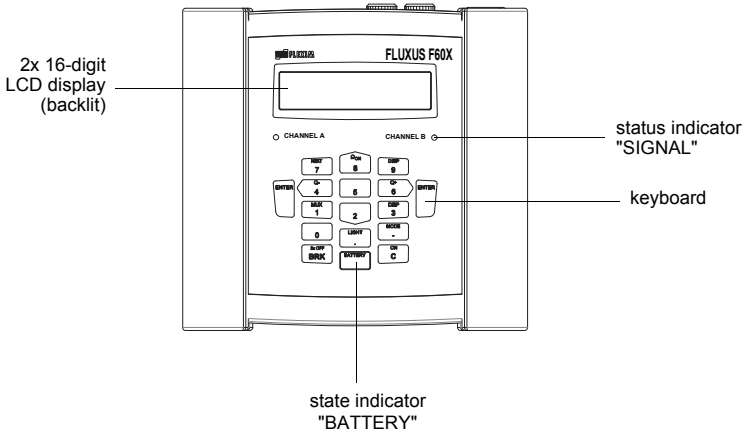

Fig. 4.1: Command panel

A handle is mounted to the back side of the transmitter (see Fig. 4.2). It can also be used as support. The opening in the support plate is used to fasten the transmitter to the pipe (see section 6.2.3 or 7.2.3).

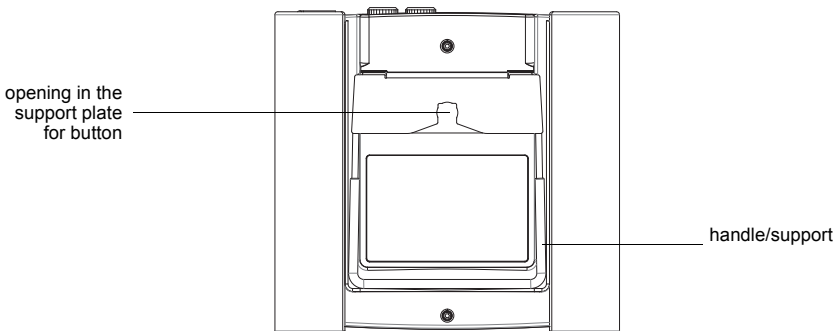

Fig. 4.2: Back side

4.2 Status Indication

Tab. 4.1: LED "SIGNAL"

LED off	transmitter in idle state (offline)
LED lights green	signal quality of the measuring channel sufficient for a measurement
LED lights red	signal quality of the measuring channel not sufficient for a measurement

Tab. 4.2: LED "BATTERY"





LED flashes green	battery is being charged
LED lights green	battery is charged
LED off	charge state of the battery > 10 %
LED flashes red	charge state of the battery < 10 %

Note!	If the LED "BATTERY" flashes red/green, the power supply has an internal error. Contact FLEXIM for more information.
--------------	--

4.3 Keyboard

The keyboard consists of 3 function keys ENTER, BRK and C, the status indicator BATTERY and 10 numerical keys.





Several keys have double functions. They can be used for entering data and for navigating through scroll lists.

The arrow-shaped numerical keys , ,  and  are used as cursor keys in the selection mode and for entering digits and letters in the input mode.



Tab. 4.3: general functions

C	switching on the transmitter
LIGHT	switching on/off the backlight of the display
ENTER	confirmation of selection or entered value
BRK + C + ENTER	RESET: Press these three keys simultaneously to correct a malfunction. The reset has the same effect as restarting the transmitter. Stored data are not affected.
BRK	interruption of the measurement and selection of the main menu Be careful not to stop a current measurement by inadvertently pressing key BRK!
BRK	switching off the transmitter by pressing key BRK three times





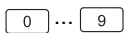





Tab. 4.4: Navigation

BRK	selection of the main menu
 	scroll to the left/right through a scroll list
 	scroll upwards/downwards through a scroll list
ENTER	confirmation of the selected menu item

Tab. 4.5: Input of digits

	input of the digit shown on the key
	sign for the input of negative values
	decimals
C	Delete values. After the value has been deleted, the previous value will be displayed.
ENTER	Confirmation of input.

Tab. 4.6: Input of text

 	positioning of the cursor
	changing the currently selected character to an "A"
	changing the currently selected character to a "Z"
	changing between small and capital letters
 	selection of the previous/next ASCII character
	deleting the character and inserting a blank
 	Automatic scrolling up or down through the limited ASCII character set. The character changes every second. The scrolling is stopped by pressing any other key.
ENTER	finishing editing

5 Selection of the Measuring Point

Attention!	Observe the Safety Instructions for the Use in Explosive Atmosphere (see document SIFLUXUS_608).
-------------------	--

The correct selection of the measuring point is crucial for achieving reliable measurement results and a high measurement accuracy.

A measurement on a pipe is possible if

- the ultrasound propagates with a sufficiently high amplitude (see section 5.1)
- the flow profile is fully developed (see section 5.2)

The correct selection of the measuring point and thus, the correct transducer positioning guarantees that the sound signal will be received under optimum conditions and evaluated correctly.

Due to the variety of applications and the different factors that influence the measurement, there is no standard solution for the transducer positioning. The correct position of the transducers is influenced by the following factors:

- diameter, material, lining, wall thickness and shape of the pipe
- fluid
- gas bubbles in the fluid

Avoid measuring points in the vicinity of deformations and defects of the pipe and in the vicinity of welds.

Avoid locations with deposit formation in the pipe.

The ambient temperature at the measuring point has to be within the operating temperature range of the transducers (see Technical Specification (FLUXUS F601) or (FLUXUS F608)).

Select the location of the transmitter within the range of the cable of the measuring point.

The ambient temperature at the measuring point has to be within the operating temperature range of the transmitter (see Technical Specification (FLUXUS F601) or (FLUXUS F608)).

If the measuring point is within an explosive atmosphere, the danger zone and gases that may be present have to be determined. The transducers and the transmitter have to be appropriate for these conditions.

5.1 Acoustic Penetration

The pipe has to be acoustically penetratable at the measuring point. The acoustic penetration is reached when pipe and fluid do not attenuate the sound signal so strongly that it is completely absorbed before reaching the second transducer.

The attenuation in the pipe and in the fluid depends on:

- kinematic viscosity of the fluid
- proportion of gas bubbles and solids in the fluid
- deposits on the inner pipe wall
- pipe material

The following requirements have to be met at the measuring point:

- the pipe is always filled completely
- no material deposits in the pipe
- no bubbles accumulate

Note! Even bubble-free fluids can form gas pockets when the fluid expands, e.g., before pumps and after great cross-section extensions.

Observe the notes in the following table:

Tab. 5.1: Recommended transducer mounting position

horizontal pipe

Select a measuring point where the transducers can be mounted on the side of the pipe, allowing the sound waves to propagate in the pipe horizontally. . . By doing this, the solid on the bottom of the pipe or gas bubbles in the pipe's upper part are prevented from influencing the propagation of the signal.

correct :

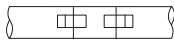

disadvantageous:



vertical pipe

Select the measuring point at a pipe location where the fluid flows upward. The pipe has to be completely filled.

correct :

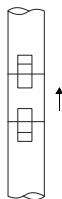

disadvantageous:

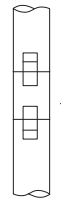

Tab. 5.1: Recommended transducer mounting position

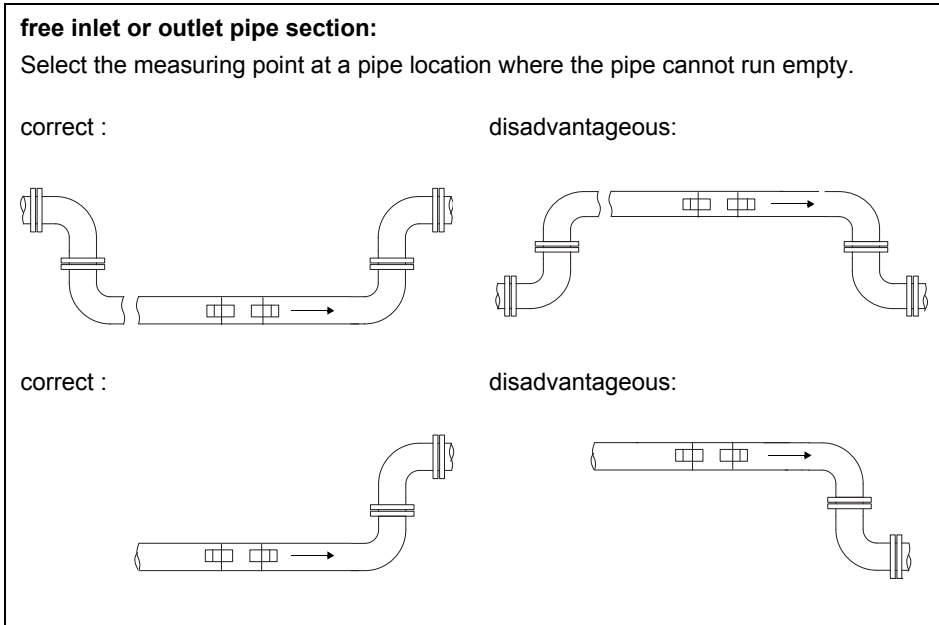

5.2 Undisturbed Flow Profile

Some flow elements (elbows, slide valves, valves, control valves, pumps, reducers, diffusers, etc.) distort the flow profile in their vicinity. The axisymmetrical flow profile needed for correct measurement is no longer given. A careful selection of the measuring point helps to reduce the impact of disturbance sources.

It is most important that the measuring point is chosen at a sufficient distance from any disturbance sources. Only then it can be assumed that the flow profile in the pipe is fully developed. However, measuring results can be obtained even if the recommended distance to disturbance sources cannot be observed for practical reasons.

Recommended straight inlet and outlet pipe lengths for different types of flow disturbance sources are shown in the examples in Tab. 5.2.

Tab. 5.2 Recommended distance from disturbance sources

D = nominal pipe diameter at the measuring point, l = recommended distance

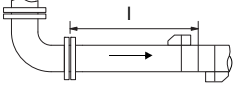
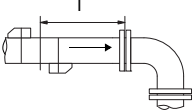
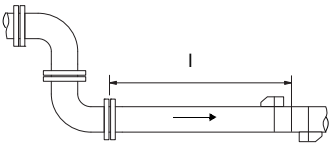
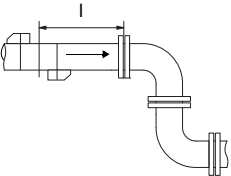
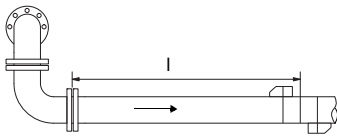
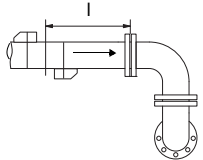
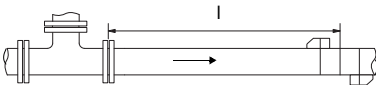
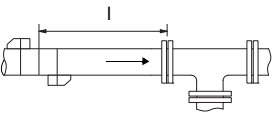
disturbance source: 90° elbow	
supply line: $l \geq 10 D$	return line: $l \geq 5 D$
	
disturbance source: 2x 90° elbows on same level	
supply line: $l \geq 25D$	return line: $l \geq 5 D$
	
disturbance source: 2x 90° elbows on different level	
supply line: $l \geq 40 D$	return line: $l \geq 5 D$
	
disturbance source: T piece	
supply line: $l \geq 50 D$	return line: $l \geq 10 D$
	

Tab. 5.2 Recommended distance from disturbance sources

D = nominal pipe diameter at the measuring point, l = recommended distance

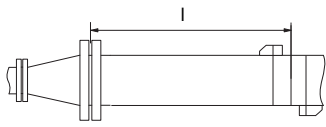
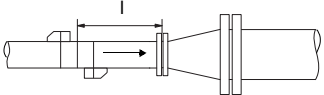
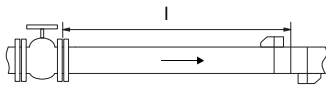
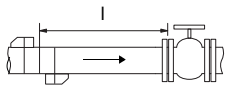
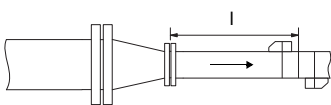
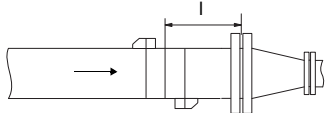
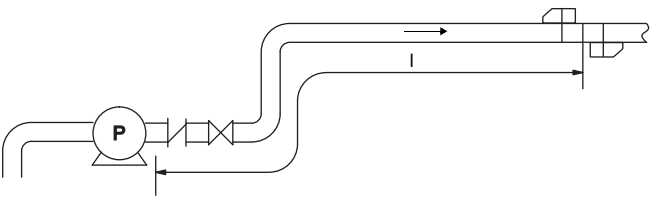
<p>disturbance source: diffuser</p> <p>supply line: $l \geq 30 D$</p> 	<p>return line: $l \geq 5 D$</p> 
<p>disturbance source: valve</p> <p>supply line: $l \geq 40 D$</p> 	<p>return line: $l \geq 10 D$</p> 
<p>disturbance source: reducer</p> <p>supply line: $l \geq 10 D$</p> 	<p>return line: $l \geq 5 D$</p> 
<p>disturbance source: pump</p> <p>supply line: $l \geq 50 D$</p> 	

5.3 Selection of the Measurement Arrangement Taking into Account the Measuring Range and the Measuring Conditions

Diagonal arrangement with 1 beam

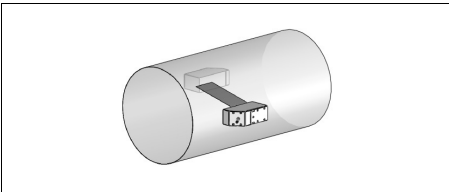

- wider flow velocity and sound speed range compared to the reflection arrangement
- use in the presence of deposits on the inner pipe wall or with strongly attenuating gases or liquids (only 1 sound path)

Reflection arrangement with 1 beam

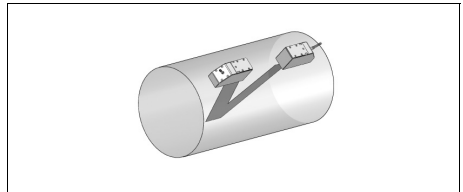

- smaller flow velocity and sound speed range compared to the diagonal arrangement
- transverse flow effects are compensated for because the beam crosses the pipe in 2 directions
- higher accuracy of measurement because the accuracy increases with the number of sound paths

Diagonal arrangement with 2 beams

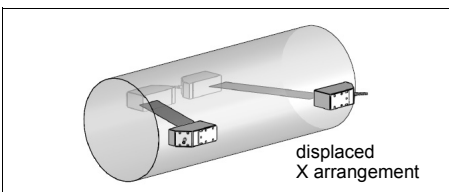
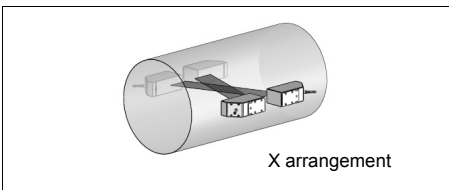

- same characteristics as diagonal arrangement with 1 beam
- additional characteristic: transverse flow effects are compensated due to measurement is conducted with 2 beams

Reflection arrangement with 2 beams and 2 planes

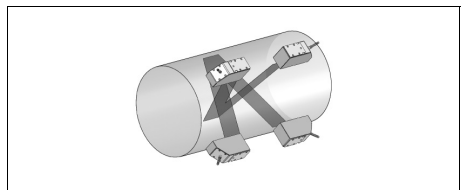

- same characteristics as reflection arrangement with 2 beams
- additional characteristic: influences of the flow profile are compensated due to measurement takes place in 2 planes

5.4 Selection of the Sound Beam Plane near an Elbow

With vertical pipe orientation

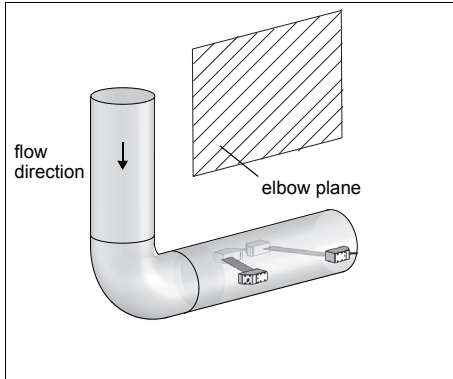

- The sound beam plane (see section 3.3.1) has an angle of 90° to the elbow plane. The elbow is upstream of the measuring point.

With horizontal pipe orientation

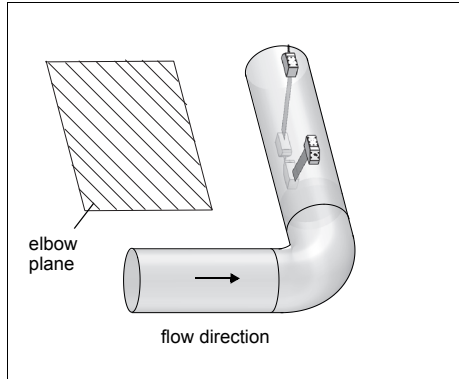

- The sound beam plane (see section 3.3.1) has an angle of $90^\circ \pm 45^\circ$ to the elbow plane. The elbow is upstream of the measuring point.

With measurements in both directions

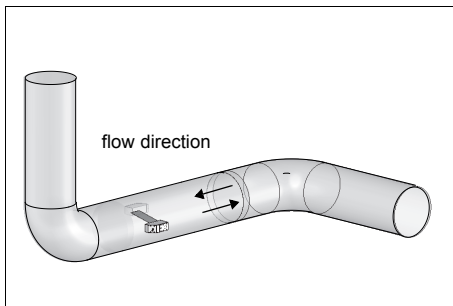

- The sound beam plane (see section 3.3.1) is selected according to the nearest elbow (horizontal or vertical, depending on the pipe orientation - see above).

With measurements in the reflection arrangement with 2 beams and -2 planes

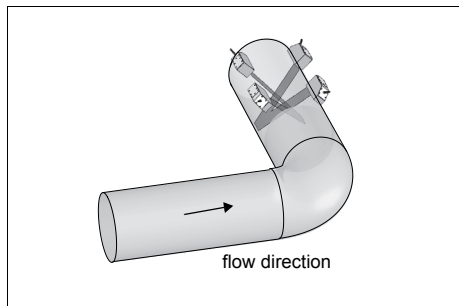

- The 2 sound beam planes (see section 3.3.1) have an angle of 45° to the elbow plane. The elbow is upstream of the measuring point.
- With horizontal pipes, the transducers are mounted on the upper half of the pipe.

6 Installation of FLUXUS F601

6.1 Location

Select the measuring point according to the recommendations in chapter 3 and 5. The ambient temperature at the measuring point has to be within the operating temperature range of the transmitter and the transducers (see Technical Specification).

6.2 Installation of the Transmitter

6.2.1 Placement

Push the support back to the stop of the support plate.

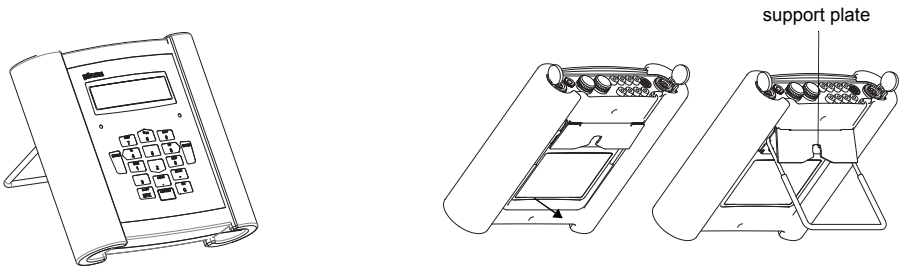

Fig. 6.1: Placement of the transmitter

6.2.2 Hanging

Press both ends of the handle outwards and pass them past the support plate. Turn the handle upwards.

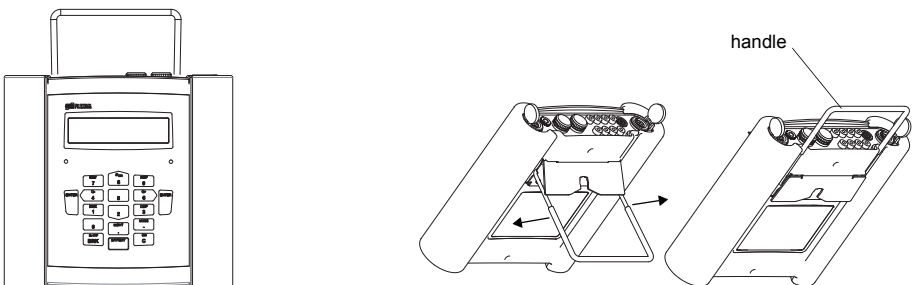

Fig. 6.2: Hanging the transmitter

6.2.3 Installation on a Pipe

Attention! The pipe temperature must not exceed the operating temperature of the transmitter.

Fix the tension belt to the pipe with the button. Tighten the tension belt by means of the ratchet. Insert the button into the opening in the support plate on the back side of the transmitter (see Fig. 6.3 and Fig. 6.4).

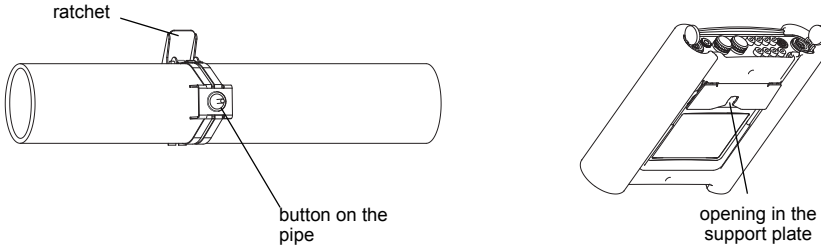

Fig. 6.3: Pipe Installation

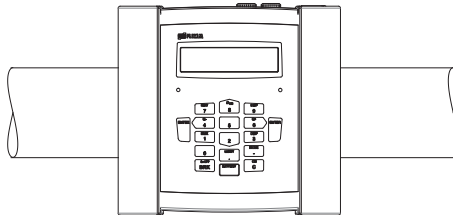

Fig. 6.4: Transmitter on the pipe

6.3 Connection of the Transducers

The connections are on the upper side of the transmitter (see Fig. 6.5).

- Pull up the socket cover (see Fig. 6.6).
- Insert the connector of the transducer cable into the socket of the transmitter. The red point (a) on the connector has to align with the red marking (b) on the socket.

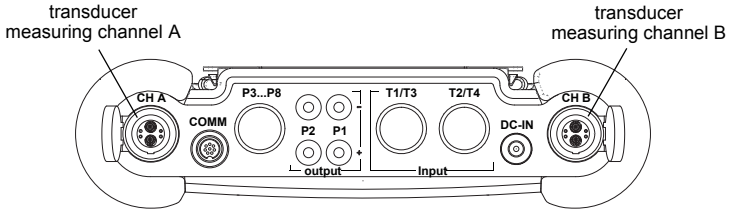

Fig. 6.5: Connections of the transmitter FLUXUS F601

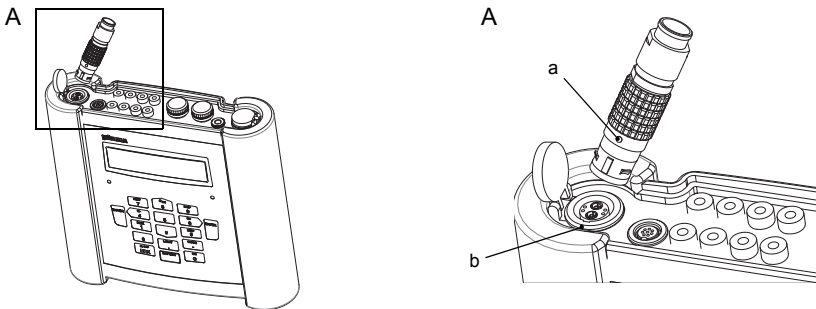

Fig. 6.6: Connection of the transducers

6.4 Power Supply

The transmitter can be operated with the battery (see section 6.4.1) or with the power supply unit (see section 6.4.2).

6.4.1 Operation with Battery

The transmitter has a Li-Ion battery and can be operated independently of the power supply unit. When delivered, the battery is charged approx. 30 %. The battery does not need to be fully charged before it is used for the first time.

The charge state of the battery can be displayed during the measurement (see section 12.3) and in the program branch `Special Funct.:`

```
Special Funct. ↓
Battery status
```

```
■■■ 30%-
Cy: 1
```

Select `Special Funct.\Battery status`. Press ENTER.

The current charge state of the battery is displayed (here: 30 %).

The minus sign "-" indicates that the transmitter is in battery mode and is being discharged.

The number of cycles the battery has passed is displayed after `Cy:`.

A cycle corresponds to a charging and discharging process. The life time of the battery can be derived by means of this value.

If `RELEARN` is displayed in the lower line and a question mark "?" is displayed in front of the current charge state, a relearn cycle should be started (see section Maintenance on the following page).

This message will be displayed if the battery is almost empty:

```
LOW BATTERY !
```

The capacity is sufficient for the display and storing of the current parameter record. A measurement is no longer possible.

Charging the battery

Connect the power supply unit to the transmitter (see Fig. 6.7). Switch on the transmitter. The charging starts automatically. The LED "BATTERY" flashes green while charging. The max. charging time is approx. 5 h.

During the charging process, the ambient temperature should be in the range 0...45 °C.

A measurement can be made during the charging. Charging will be stopped automatically when the battery is fully charged. The LED "BATTERY" will light green.

Note! The battery will only be charged if the transmitter is switched on.

Storage of the battery

The battery remains in the transmitter. After storage, the transmitter can immediately be operated with the battery.

- charge state: > 30 %
- storing temperature: 12...25 °C

Maintenance (relearn cycle)

The accuracy of the displayed value for the charge state of the battery is improved by executing a relearn cycle. The ambient temperature during a relearn cycle should be in the range 12...30 °C.

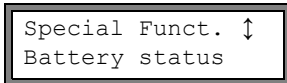

Select Special Funct.\Battery status. Press ENTER.

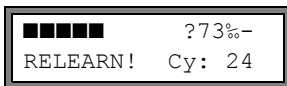

The charge state of the battery is displayed (here: 73 %).

The "?" and RELEARN indicate that the displayed charge state is not reliable. A relearn cycle is recommended.

Proceed as follows for a relearn cycle:

- Charge the battery completely. The LED "BATTERY" lights green when charging is finished.
- Discharge the battery completely: Remove the power supply unit from the transmitter. To deactivate the automatic power off during discharging, start a measurement. Discharging takes min. 14 h. The LED "BATTERY" will flash red afterwards.

Automatic power off

In the battery mode, the transmitter has an automatic power off. The transmitter will be switched off if

- no measurement is being made and no key is pressed within 10 min or
- the battery is empty

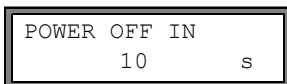

This message will be displayed before the transmitter is switched off automatically. A countdown with an acoustic signal will be started.

The countdown can be stopped by pressing any key.

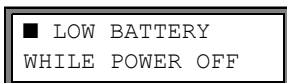

If this message is displayed when the transmitter is switched on, the transmitter has been switched off automatically due to a too low charge state.

6.4.2 Operation with the Power Supply Unit

Attention!

- Use only the supplied power supply unit.
- The power supply is not protected against moisture. Use it only in dry rooms.
- The voltage indicated on the power supply unit must not be exceeded.
- Do not connect a defective power supply unit to the transmitter.

- Connect the power supply unit to the socket on the upper side of the transmitter (see Fig. 6.7).

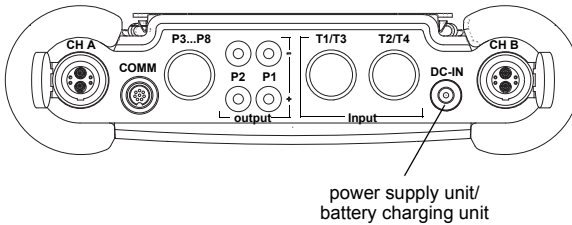

Fig. 6.7: Connections of the transmitter FLUXUS F601

6.5 Connection of the Outputs

Note!

For the connection, observe the specifications regarding the assignment of the outputs given on the nameplate on the backside of the transmitter.

Attention!

The outputs can only be connected to a low voltage circuit (max. 30 V AC or 42 V DC against earth).

For the connection of the outputs, see Fig. 6.8 and Tab. 6.1.

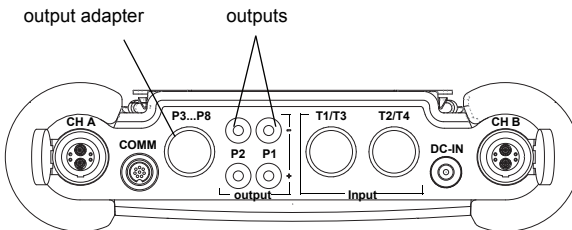

Fig. 6.8: Connections of the transmitter FLUXUS F601

Tab. 6.1: Circuits of the outputs

output	transmitter		external circuit	remark
	internal circuit	connection		
active current loop		PX+ PX-		$R_{ext} < 200 \Omega$
passive current loop (semi-passive design, used as active current loop)		PX+ (red) PX- (black)		$R_{ext} < 50 \Omega$ e.g., for local connection of a multimeter
passive current loop (semi-passive design)		PX+ (red) PX- (black)		$U_{ext} = 4 \dots 16 \text{ V}$ $U_{ext} > 0.021 \text{ A} \cdot R_{ext} [\Omega] + 4 \text{ V}$ example: $U_{ext} = 12 \text{ V}$ $R_{ext} \leq 380 \Omega$
frequency output		PX+ PX-		$U_{ext} = 5 \dots 24 \text{ V}$ $R_c [\text{k}\Omega] = U_{ext} / I_c [\text{mA}]$ $I_c = 1 \dots 4 \text{ mA}$
binary output (optorelay)		PX+ PX-		$U_{ext} \leq 26 \text{ V}$ $I_c \leq 100 \text{ mA}$

The number, type and connections of the outputs are customized.

R_{ext} is the sum of all ohmic resistances in the circuit (e.g., resistance of the conductors, resistance of the amperemeter/voltmeter).

Connection of an output adapter

The number of outputs can be increased to max. 8 by connecting an output adapter (optional) (see Fig. 6.8 and Fig. 6.9).

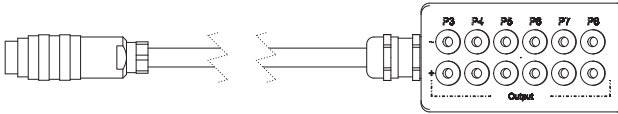

Fig. 6.9: Output adapter

6.6 Connection of the Inputs

Note! For the connection, observe the specifications regarding the assignment of the inputs given on the nameplate on the backside of the transmitter.

Attention! The inputs can only be connected to a low voltage circuit (max. 30 V AC or 42 V DC against earth).

6.6.1 Connection of a Temperature Input

Temperature probes Pt100/Pt1000 (4-wire) can be connected to the inputs of the transmitter (optional) (see Fig. 6.10).

For the assignment and the activation of the temperature inputs see chapter 21.

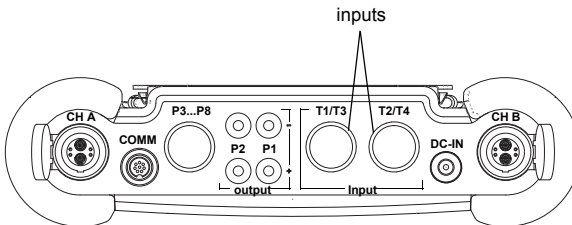
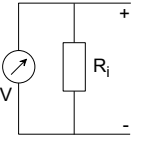
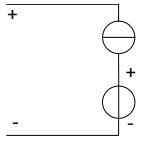

Fig. 6.10: Connections of the transmitter FLUXUS F601

6.6.2 Connection of a Passive Current Input

An active current source or a passive current source with an external power supply can be connected to a passive current input.

Tab. 6.2: Connection of an active current source

input	transmitter		external circuits	comments
	internal circuit	connection		
passive current input			max. permanent overcurrent: 40 mA	

If the polarity of the current source is inverted, only the sign of the measured current will change.

Tab. 6.3: Connection of a passive current source

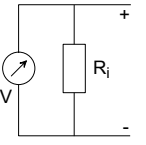
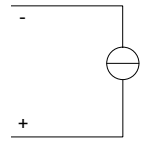
input	transmitter		external circuits	comments
	internal circuit	connection		
passive current input			short circuit current: max. 40 mA	

An external voltage source U_{ext} is necessary. It has to provide a current of min. 20 mA and

- supply sufficient power for the requirements of the passive current source and
- cover the voltage drop at the input resistor (1 V at 20 mA) and
- cover all other voltage drops (e.g., cable resistance) in the circuit.

If the transmitter has an active output see chapter 6.6.4.

example: A passive current source (e.g., a pressure sensor) is to be connected to a passive current input.

technical data of the pressure sensor:

$$U_S = 11 \dots 30 \text{ V DC}$$

$$I_a = 4 \dots 20 \text{ mA } (I_{a \text{ max}} = 22 \text{ mA})$$

U_{ext} required for the operation of the passive pressure sensor is:

$$\begin{aligned} U_{\text{ext min}} &= U_{S \text{ min}} + I_{a \text{ max}} \cdot R_i + I_{a \text{ max}} \cdot R_c \\ &= 11 \text{ V} + 22 \text{ mA} \cdot 50 \Omega + 20 \text{ mA} \cdot 2 \Omega \\ &= 12.14 \text{ V} \end{aligned}$$

$$\begin{aligned} U_{\text{ext max}} &= U_{S \text{ max}} \\ &= 30 \text{ V} \end{aligned}$$

U_S – operating voltage of the pressure sensor

I_a – output current

R_i – input resistance

R_c – cable resistance

6.6.3 Input Adapter

The number of temperature inputs can be increased to max. 4 by means of 2 input adapters (optional) (see Fig. 6.11).

If the transmitter has voltage or current inputs, the adapter for voltage and current inputs will be used (see Fig. 6.12).

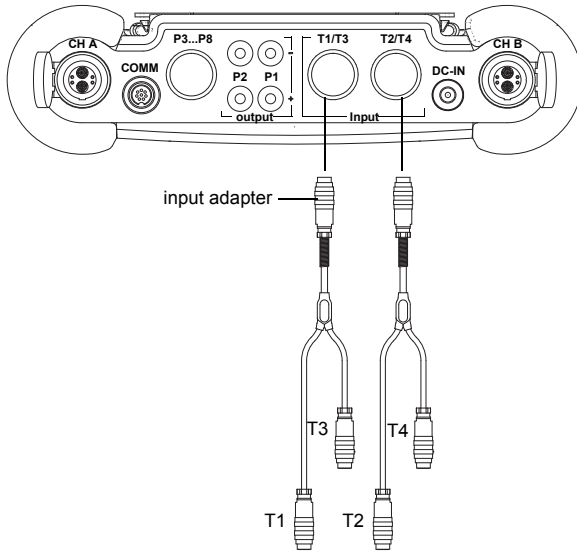

Fig. 6.11: Connection of the input adapters

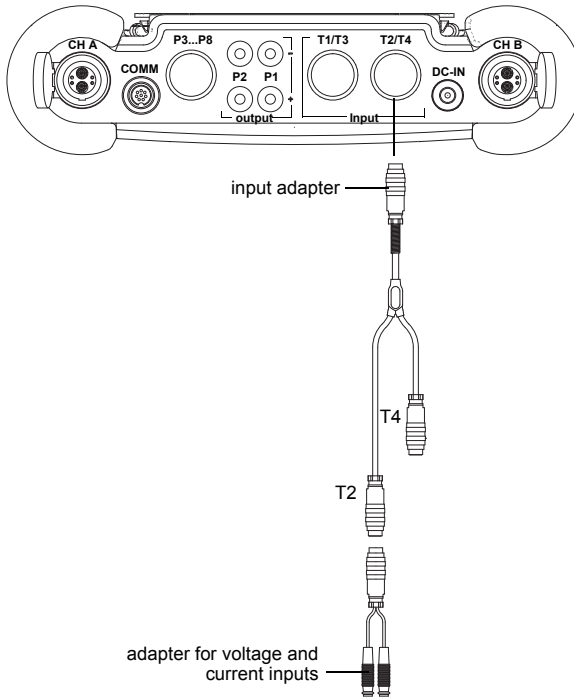

Fig. 6.12: Connection of the adapter for the voltage and current inputs

6.6.4 Connection of an Active Input

For the connection of a passive current source to a passive current input, an external power supply has to be provided.

If the transmitter has the active output, the output can be used as power supply by means of an adapter. For the connection of the adapter see Fig. 6.13 and Tab. 6.4.

The adapter establishes the connection between the active output and the passive input of the transmitter. At the same time, the passive current source is connected via the adapter.

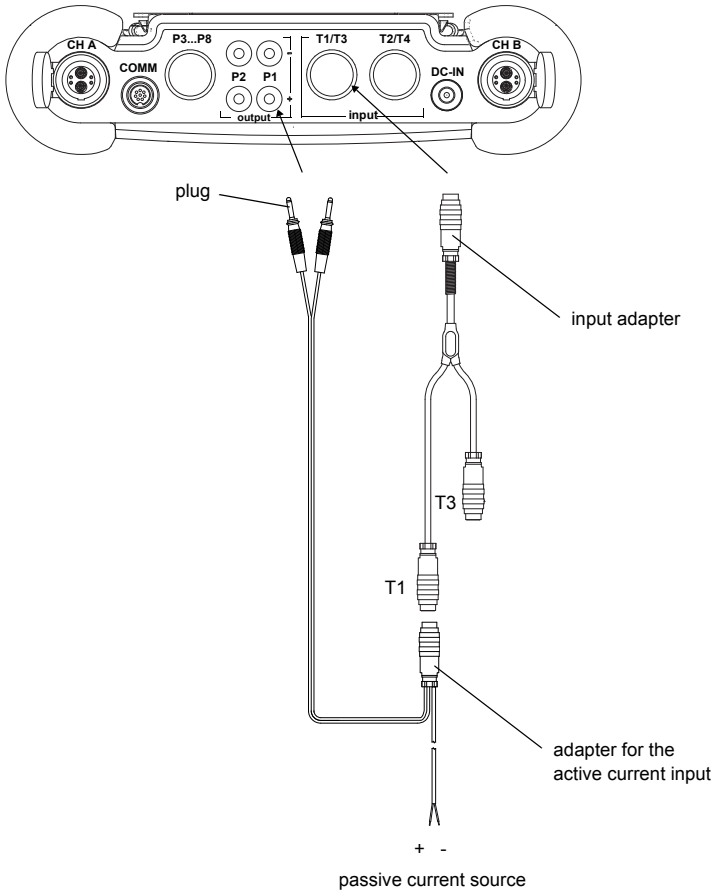
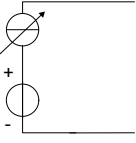
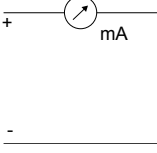

Fig. 6.13: Connection of the adapter for the active current input

Tab. 6.4: Circuits of the outputs when connecting an active input

output	transmitter		external circuit	remark
	internal circuit	connection		
active current loop		PX+ PX-		$R_{ext} < 200 \Omega$ $U_{int} = 24 \text{ V DC}$

For the configuration of the output see section 22.4.

6.7 Connection of the Serial Interface

- Connect the RS232 cable to the transmitter (see Fig. 6.14) and to the serial interface of the PC.
- Use the RS232 adapter for the connection of the RS232 cable to the transmitter. If the RS232 cable cannot be connected to the PC, use the RS232/USB adapter.

The RS232 adapter, the RS232 cable and the RS232/USB adapter are part of the serial data kit (optional).

Note! If a problem occurs when the RS232/USB adapter is used for the connection, contact your system administrator.

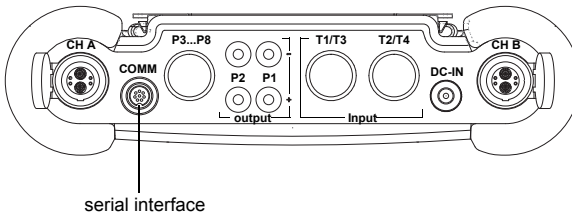

Fig. 6.14: Connections of the transmitter FLUXUS F601

7 Installation of FLUXUS F608

7.1 Location

Attention! Observe the Safety Instructions for the Use in Explosive Atmosphere (FLUXUS F608**-A2: see document SIFLUXUS_608, FLUXUS F608**-F2: see document SIFLUXUS_608F2).

Select the measuring point according to the recommendations in chapter 3 and 5. The ambient temperature at the measuring point has to be within the operating temperature range of the transmitter and the transducers (see Technical Specification (FLUXUS F608**-A2) or (FLUXUS F608**-F2)).

7.2 Installation of the Transmitter

Attention! Observe the Safety Instructions for the Use in Explosive Atmosphere (FLUXUS F608**-A2: see document SIFLUXUS_608, FLUXUS F608**-F2: see document SIFLUXUS_608F2).

7.2.1 Placement

Push the support back to the stop of the support plate.

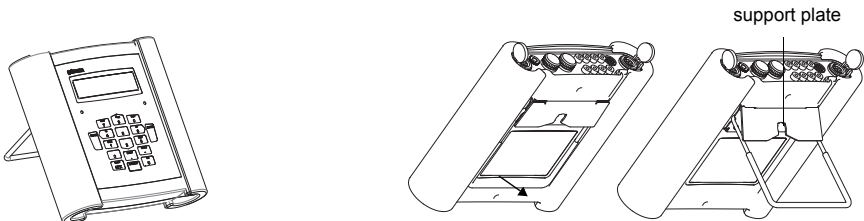

Fig. 7.1: Placement of the transmitter

7.2.2 Hanging

Press both ends of the handle outwards and pass them past the support plate. Turn the handle upwards.

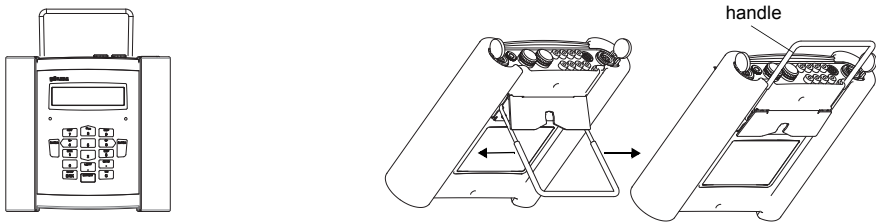

Fig. 7.2: Hanging the transmitter

7.2.3 Installation on a Pipe

Attention! The pipe temperature must not exceed the operating temperature of the transmitter.

Fix the tension belt to the pipe with the button. Tighten the tension belt by means of the ratchet. Insert the button into the opening in the support plate on the back side of the transmitter (see Fig. 7.3 and Fig. 7.4).

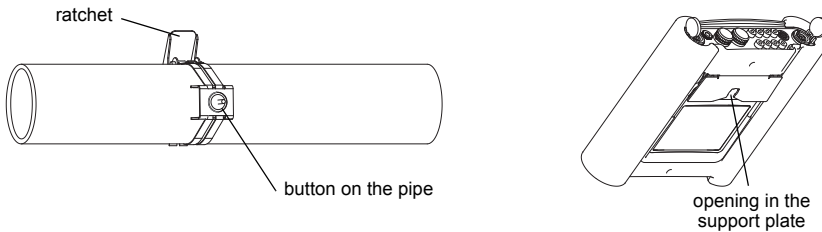

Fig. 7.3: Pipe installation

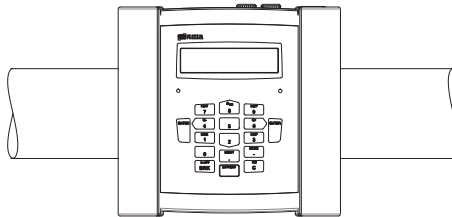

Fig. 7.4: Transmitter on the pipe

7.3 Connection of the Transducers

Attention! Observe the Safety Instructions for the Use in Explosive Atmosphere (FLUXUS F608**-A2: see document SIFLUXUS_608, FLUXUS F608**-F2: see document SIFLUXUS_608F2).

7.3.1 Connection of the Transducers to the Transmitter FLUXUS F608**-A2

The connections are on the upper side of the transmitter (see Fig. 7.5).

- Remove the blind plug (see Fig. 7.6).
- Insert the connector of the transducer cable into the socket of the transmitter. The red point (a) on the connector has to align with the red marking (b) on the socket (see Fig. 7.7).

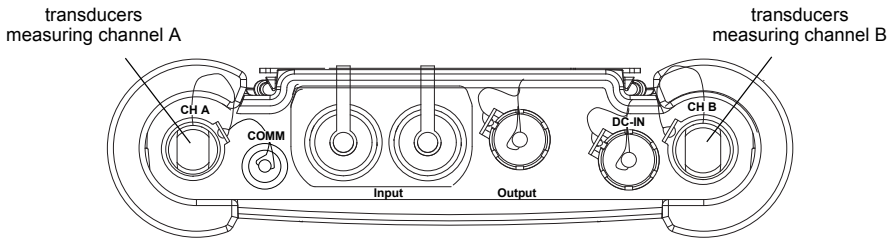

Fig. 7.5: Connections of the transmitter FLUXUS F608**-A2

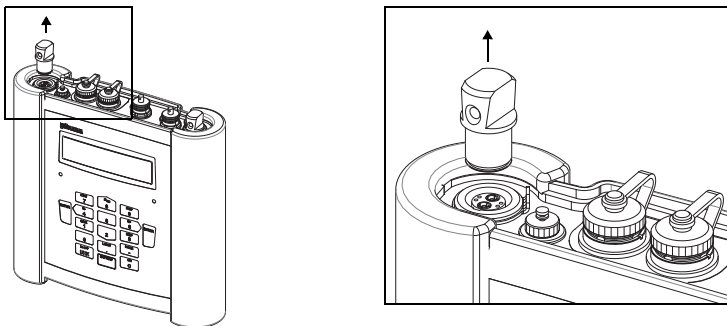

Fig. 7.6: Removal of the blind plug (FLUXUS F608**-A2)

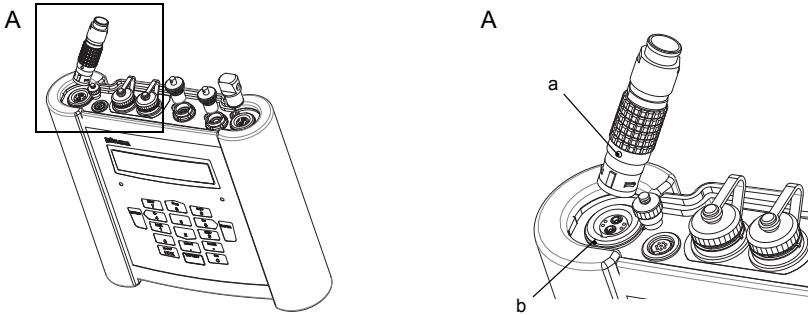

Fig. 7.7: Connection of the transducers (FLUXUS F608**-A2)

7.3.2 Connection of the Transducers to the Transmitter FLUXUS F608**-F2

The connections are on the upper side of the transmitter (see Fig. 7.8).

- Remove the substitute plug, if present.
- Insert the connector of the transducer cable into the socket of the transmitter. The red point (a) on the connector has to align with the red marking (b) on the socket (see Fig. 7.9).
- Secure the connector with of the lock ring by tightening the lock screw (see Fig. 7.10).
- If a socket for the connection of transducers is not used, close it with a substitute plug. Secure the substitute plug by tightening the lock screw.

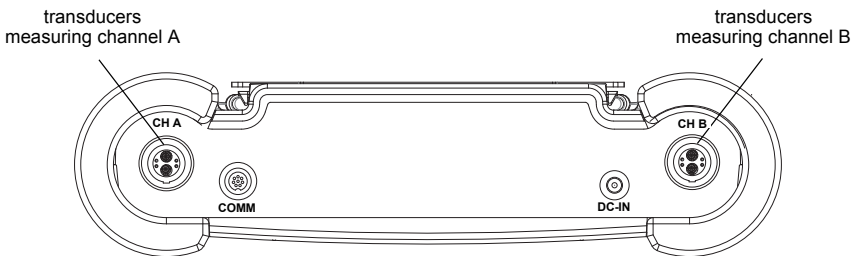

Fig. 7.8: Connections of the transmitter FLUXUS F608**-F2

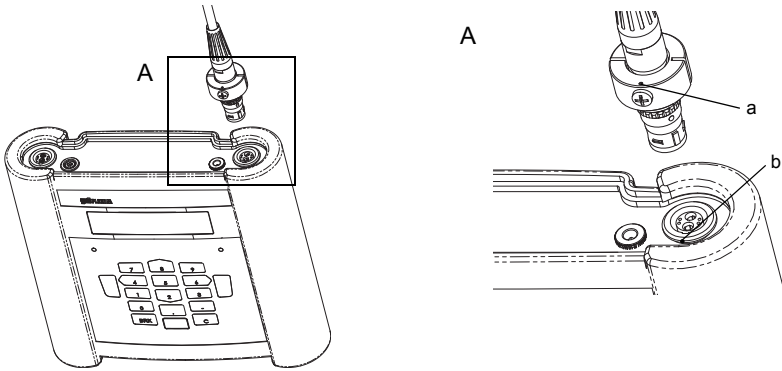

Fig. 7.9: Connection of the transducers (FLUXUS F608**-F2)

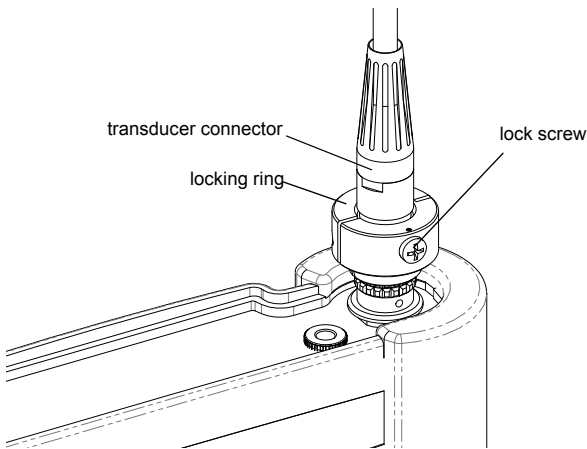

Fig. 7.10: Connection of the transducers (FLUXUS F608**-F2)

7.4 Power Supply

The transmitter can be operated with

- the battery (see section 7.4.1) or
- the power cable and the power adapter (FLUXUS F608**-A2, optional, see section 7.4.2) or
- the power supply unit (FLUXUS F608**-F2, see section 7.4.3).

7.4.1 Power Supply with Battery

Attention! Observe the Safety Instructions for the Use in Explosive Atmosphere (FLUXUS F608**-A2: see document SIFLUXUS_608, FLUXUS F608**-F2: see document SIFLUXUS_608F2).

The transmitter has a Li-Ion battery and can be operated independently of the power cable. When delivered, the battery is charged approx. 30 %. The battery does not need to be fully charged before it is used for the first time.

The charge state of the battery can be displayed during the measurement (see section 12.3) and in the program branch `Special Funct.:`

```
Special Funct. ↑
Battery status
```

Select `Special Funct.\Battery status`. Press `ENTER`.

```
■■■■ 30%-
      Cy: 1
```

The current charge state of the battery is displayed (here: 30 %).

The minus sign "-" indicates that the transmitter is in battery mode and is being discharged.

The number of cycles the battery has passed is displayed after `Cy:`.

A cycle corresponds to a charging and discharging process. The life time of the battery can be derived by means of this value.

If `RELEARN` is displayed in the lower line and a question mark "?" is displayed in front of the current charge state, a relearn cycle should be started (see section Maintenance on the following page).

This message will be displayed if the battery is almost empty:

```
LOW BATTERY !
```

The capacity is sufficient for the display and storing of the current parameter record. A measurement is no longer possible.

Charging the battery

Attention! Observe the Safety Instructions for the Use in Explosive Atmosphere (FLUXUS F608**-A2: see document SIFLUXUS_608, FLUXUS F608**-F2: see document SIFLUXUS_608F2).

- Connect the power supply unit to the transmitter (see Fig. 7.11 or Fig. 7.12).
- Switch on the transmitter.

The charging starts automatically. The LED "BATTERY" flashes green while charging. The max. charging time is approx. 5 h.

During the charging process, the ambient temperature should be in the range 0...45 °C.

A measurement can be made during the charging. Charging will be stopped automatically when the battery is fully charged. The LED "BATTERY" will light green.

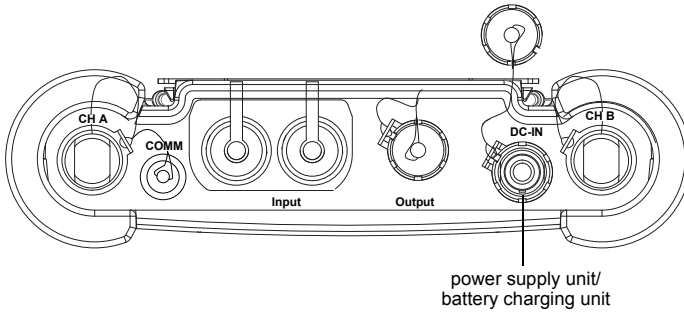

Fig. 7.11: Connections of the transmitter FLUXUS F608

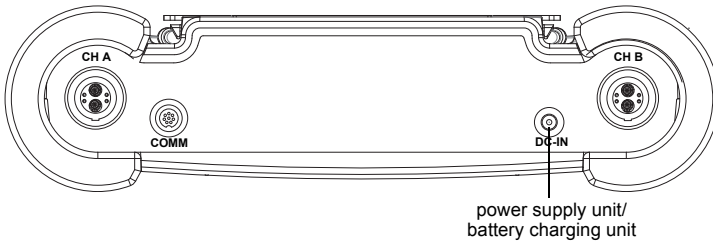

Fig. 7.12: Connections of the transmitter FLUXUS F608**-F2

Note! The battery will only be charged if the transmitter is switched on.

Storage of the battery

The battery remains in the transmitter. After storage, the transmitter can immediately be operated with the battery.

- charge state: > 30 %
- storing temperature: 12...25 °C

Maintenance (relearn cycle)

The accuracy of the displayed value for the charge state of the battery is improved by executing a relearn cycle. The ambient temperature during a relearn cycle should be in the range 12...30 °C.

```
Special Funct. ↑
Battery status
```

Select Special Funct.\Battery status. Press ENTER.

```
■■■■■ ?73%-
RELEARN! Cy: 24
```

The charge state of the battery is displayed (here: 73 %).

The "?" and RELEARN indicate that the displayed charge state is not reliable. A relearn cycle is recommended.

Proceed as follows for a relearn cycle:

- Charge the battery completely. The LED "BATTERY" lights green when charging is finished.
- Discharge the battery completely: Remove the power supply unit from the transmitter. To deactivate the automatic power off during discharging, start a measurement. Discharging takes min. 14 h. The LED "BATTERY" will flash red afterwards.

After the relearn cycle, the battery can be recharged.

Automatic power off

In the battery mode, the transmitter has an automatic power off. The transmitter will be switched off if

- no measurement is being made and no key is pressed within 10 min or
- the battery is empty

```
POWER OFF IN
  10 s
```

This message will be displayed before the transmitter is switched off automatically. A countdown with an acoustic signal will be started.

The countdown can be stopped by pressing any key.

```
■ LOW BATTERY
WHILE POWER OFF
```

If this message is displayed when the transmitter is switched on, the transmitter has been switched off automatically due to a too low charge state.

7.4.2 Power Supply with Power Cable and Power Adapter (FLUXUS F608**-A2, Optional)

Attention! Observe the Safety Instructions for the Use in Explosive Atmosphere (FLUXUS F608**-A2: see document SIFLUXUS_608, FLUXUS F608**-F2: see document SIFLUXUS_608F2).

The power adapter has to be used for the connection of the power cable.

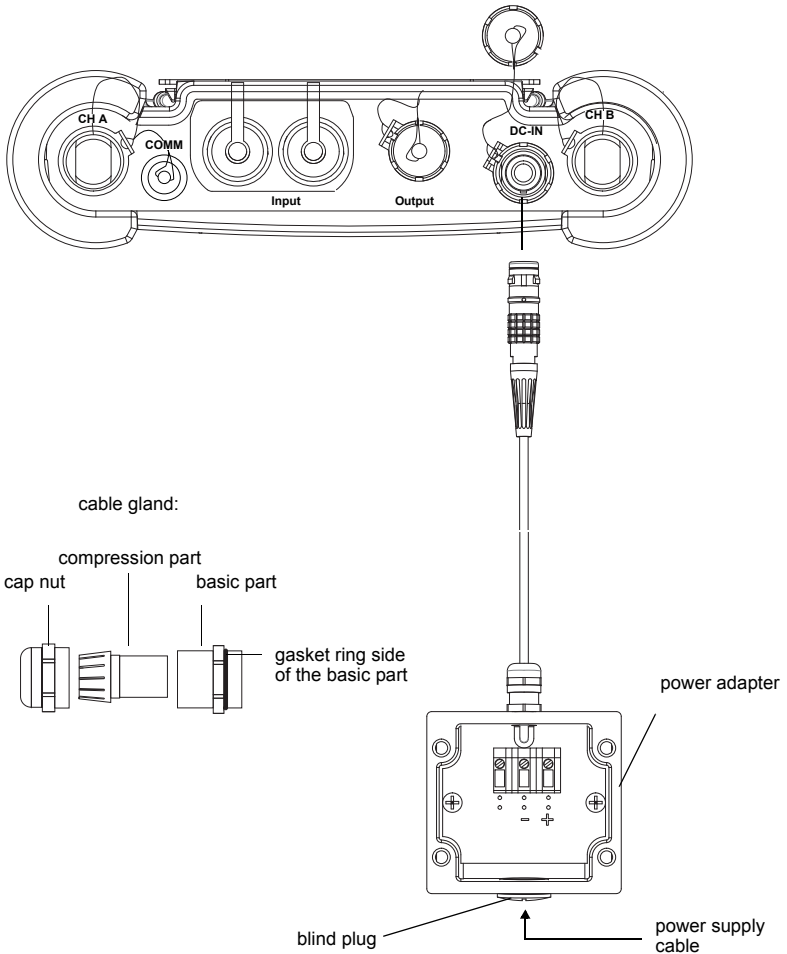

Fig. 7.13: Connection of the power adapter to the transmitter FLUXUS F608**-A2

- Remove the blind plug (see Fig. 7.13).
- Prepare the cable with an M20 cable gland.
- Push the cable through the cap nut, the compression part and the basic part of the cable gland (see Fig. 7.13).
- Insert the cable into the housing.
- Screw the gasket ring side of the basic part into the housing of the power adapter.
- Fix the cable gland by screwing the cap nut onto the basic part of the cable gland.
- Connect the cable to the terminals of the power adapter (see Fig. 7.13 and Tab. 7.1).
- Connect the connector of the power adapter to the socket of the transmitter (see Fig. 7.13).

Tab. 7.1: Terminal assignment (power adapter)

terminal	connection DC
(-)	- DC
(+)	+ DC

For the voltage see Technical Specification (FLUXUS F608**-A2) or (FLUXUS F608**-F2).

7.4.3 Power Supply with the Power Supply Unit (FLUXUS F608**-F2)

Attention!	Observe the Safety Instructions for the Use in Explosive Atmosphere (FLUXUS F608**-A2: see document SIFLUXUS_608, FLUXUS F608**-F2: see document SIFLUXUS_608F2).
-------------------	---

- | | |
|-------------------|---|
| Attention! | <ul style="list-style-type: none"> • Use only the supplied power supply unit. • The power supply is not protected against moisture. Use it only in dry rooms. • The voltage indicated on the power supply unit must not be exceeded. • Do not connect a defective power supply unit to the transmitter. |
|-------------------|---|

- Connect the power supply unit to the socket on the upper side of the transmitter (see Fig. 7.16).

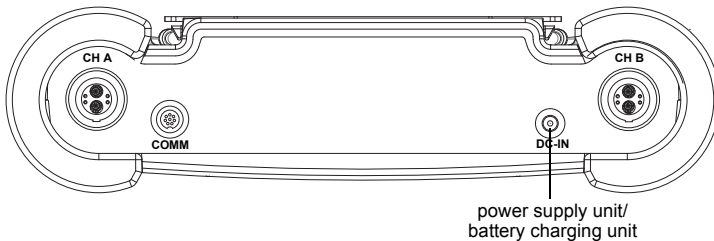

Fig. 7.14: Connections of the transmitter FLUXUS F608**-F2

7.5 Connection of the Outputs (FLUXUS F608**-A2, Optional)

Attention!	Observe the Safety Instructions for the Use in Explosive Atmosphere (FLUXUS F608**-A2: see document SIFLUXUS_608, FLUXUS F608**-F2: see document SIFLUXUS_608F2).
-------------------	---

Attention!	The outputs can only be connected to a low voltage circuit (max. 30 V AC or 42 V DC against earth).
-------------------	---

The output adapter has to be used for the connection of the output adapters (see Fig. 7.15).

- Remove the blind plug.
- Prepare the output cable with an M20 cable gland.
- Push the output cable through the cap nut, the compression part and the basic part of the cable gland (see Fig. 7.15).
- Insert the output cable into the housing (see Fig. 7.15).
- Screw the gasket ring side of the basic part into the housing of the power adapter.
- Fix the cable gland by screwing the cap nut onto the basic part of the cable gland (see Fig. 7.15).
- Connect the leads of the output cable to the terminals of the output adapter (see Fig. 7.15 and Tab. 7.2).
- Remove the socket cover from the transmitter for the connection of the output adapter (see Fig. 7.5).
- Connect the connector of the output adapter to the socket.

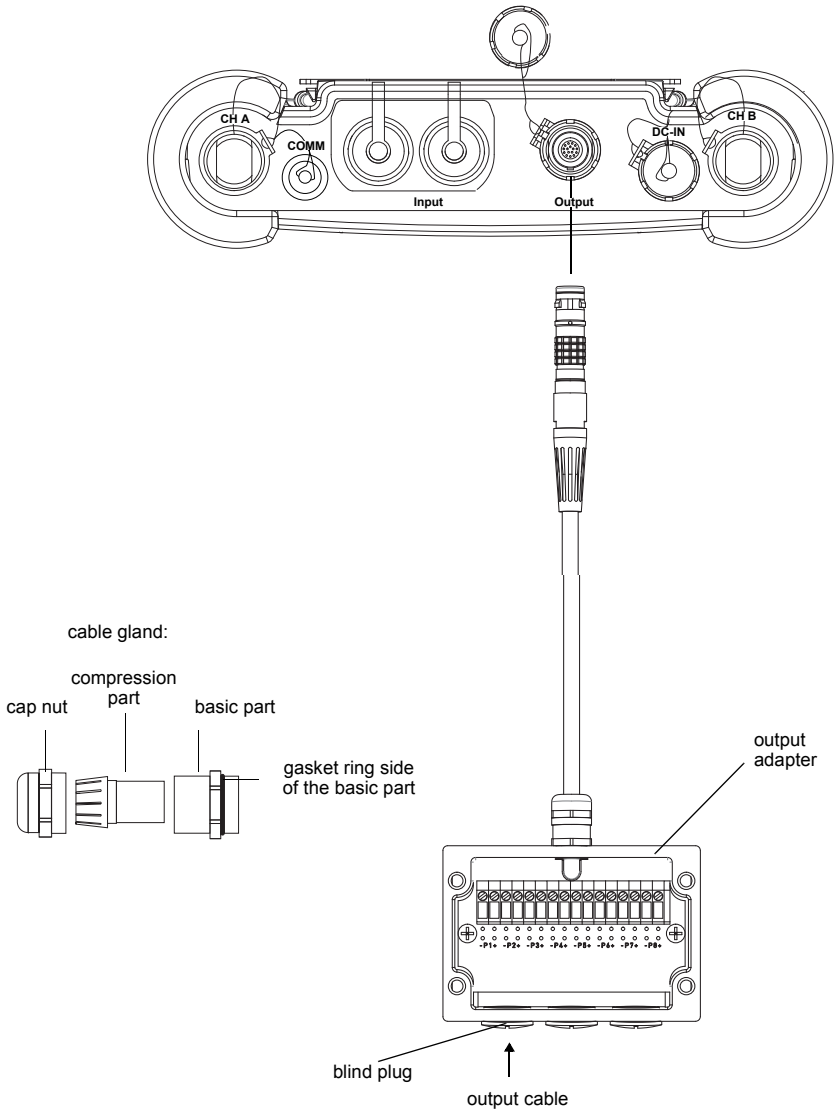
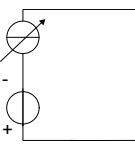
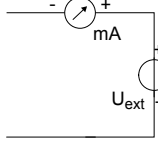
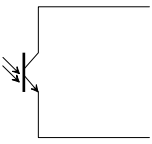
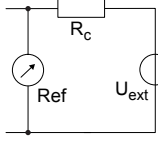
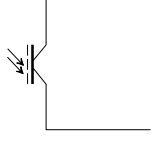
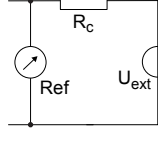

Fig. 7.15: Connection of the output adapter to the transmitter FLUXUS F608**-A2

Tab. 7.2: Circuits of the outputs

output	transmitter		external circuit	remark
	internal circuit	connection		
passive current loop (semi-passive design)		Px+ (red) Px- (black)		$U_{ext} = 4 \dots 9 \text{ V}$ $U_{ext} > 0.021 \text{ A} \cdot R_{ext} [\Omega] + 4 \text{ V}$ example: $U_{ext} = 6 \text{ V}$ $R_{ext} \leq 90 \Omega$
frequency output		Px+ Px-		$U_{ext} = 5 \dots 24 \text{ V}$ $R_c [\text{k}\Omega] = U_{ext} / I_c [\text{mA}]$ $I_c = 1 \dots 4 \text{ mA}$
binary output (optorelay)		Px+ Px-		$U_{ext} \leq 26 \text{ V}$ $I_c \leq 100 \text{ mA}$

The number, type and connections of the outputs are customized.

R_{ext} is the sum of all ohmic resistances in the circuit (e.g., resistance of the conductors, resistance of the amperemeter/volt-meter).

7.6 Connection of the Inputs (Optional)

Attention! Observe the Safety Instructions for the Use in Explosive Atmosphere (FLUXUS F608**-A2: see document SIFLUXUS_608, FLUXUS F608**-F2: see document SIFLUXUS_608F2).

Attention! The inputs can only be connected to a low voltage circuit (max. 30 V AC or 42 V DC against earth).

Note! For the connection, observe the specifications regarding the assignment of the inputs given on the nameplate on the backside of the transmitter.

7.6.1 Connection of a Temperature Input

Temperature probes Pt100/Pt1000 (4-wire) can be connected to the inputs of the transmitter (optional) (see Fig. 7.16 or Fig. 7.17).

For the assignment and the activation of the temperature inputs see chapter 21.

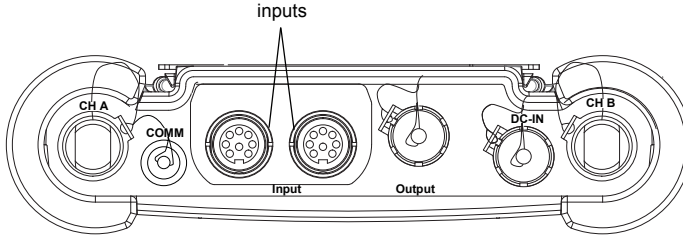

Fig. 7.16: Connections of the transmitter FLUXUS F608**-A2

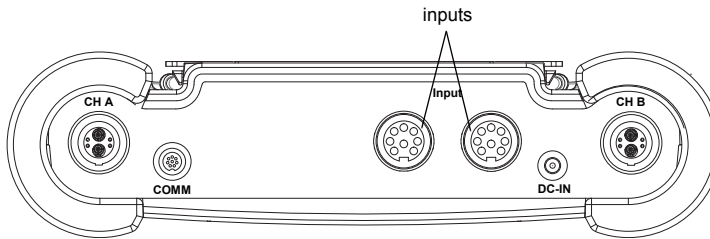

Fig. 7.17: Connections of the transmitter FLUXUS F608**-F2

7.6.2 Input Adapter (Optional)

The number of temperature inputs can be increased to max. 4 by means of 2 input adapters (see Fig. 7.18 or Fig. 7.19).

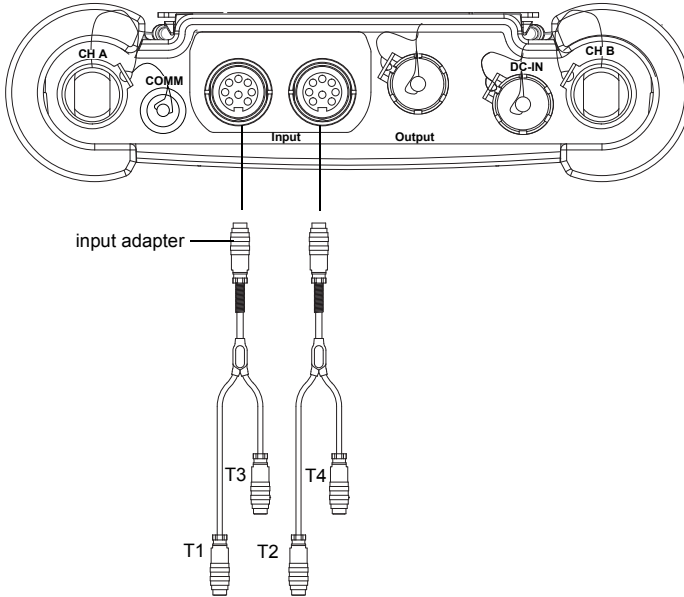

Fig. 7.18: Connection of the input adapters (FLUXUS F608**-A2)

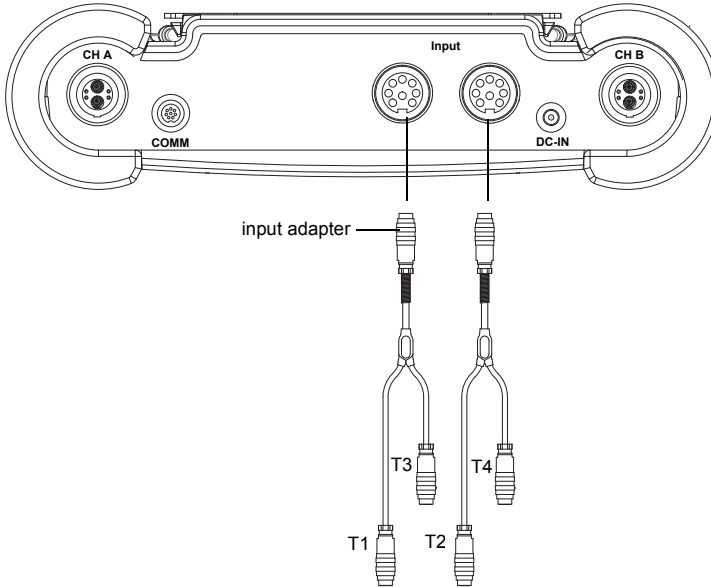

Fig. 7.19: Connection of the input adapters (FLUXUS F608**-F2)

7.7 Connection of the Serial Interface

Attention! Observe the Safety Instructions for the Use in Explosive Atmosphere (FLUXUS F608**-A2: see document SIFLUXUS_608, FLUXUS F608**-F2: see document SIFLUXUS_608F2).

- Connect the RS232 cable to the transmitter (see Fig. 7.20 or Fig. 7.21) and to the serial interface of the PC.
- Use the RS232 adapter for the connection of the RS232 cable to the transmitter. If the RS232 cable cannot be connected to the PC, use the RS232/USB adapter.

The RS232 adapter, the RS232 cable and the RS232/USB adapter are part of the serial data kit (optional).

Note! If a problem occurs when the RS232/USB adapter is used for the connection, contact your system administrator.

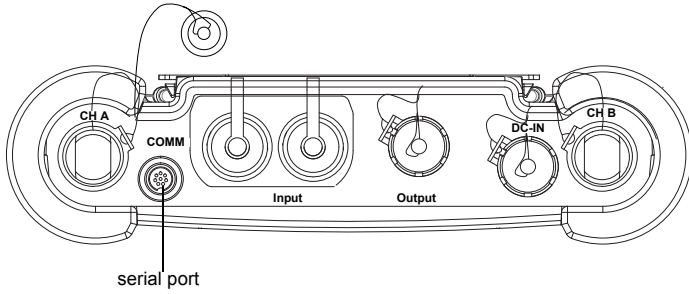

Fig. 7.20: Connections of the transmitter FLUXUS F608**-A2

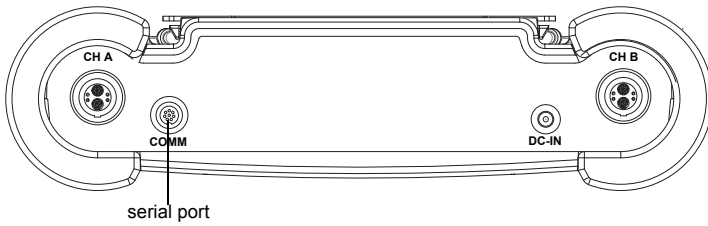

Fig. 7.21: Connections of the transmitter FLUXUS F608**-F2

8 Mounting of the Transducers

Attention! Observe the Safety Instructions for the Use in Explosive Atmosphere (see document SIFLUXUS_608).

8.1 Preparation of the Pipe

- The pipe has to be stable. It has to be able to withstand the pressure exerted by the transducer mounting fixture.

Rust, paint or other deposits on the pipe absorb the sound signal. A good acoustic contact between the pipe and the transducers is obtained as follows:

- Clean the pipe at the selected measuring point:
 - If present, the paint layer has to be smoothed by sanding. The paint does not need to be removed completely.
 - Remove any rust or loose paint.
- Use coupling foil or apply a bead of acoustic coupling compound along the center line of the contact surface of the transducers.
- Observe that there must be no air pockets between the transducer contact surface and the pipe wall.

8.2 Orientation

Mount the transducers onto the pipe in such way that the engravings on the transducers form an arrow (see Fig. 8.1). The transducer cables show in opposite directions.

For the determination of the flow direction see section 11.8.

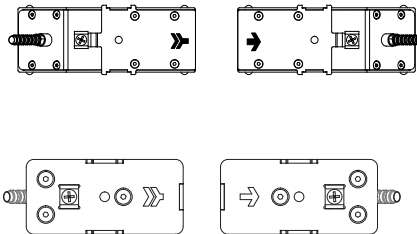

Fig. 8.1: Correct orientation of the transducers

8.3 Fixing the Transducer Cables

In order to protect the transducer cables against mechanical load, all M, P and Q transducers have to be protected by a transducer cable clips when mounted.

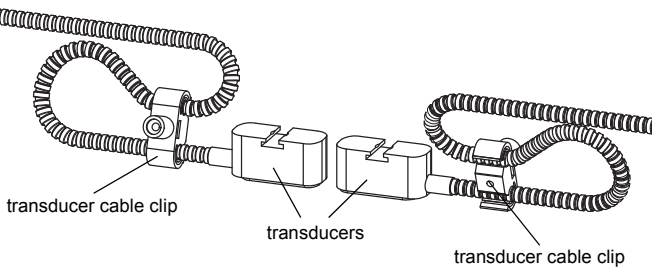

Fig. 8.2: Mounting of transducer cables clips

8.4 Installation of the Transducers with Fastening Shoes and Chains

- Insert the transducers into the fastening shoes. Turn the screw on top of the fastening shoes by 90 ° to engage and lock its end in the groove on top of the inserted transducer.
- Insert the ruler into the lateral slot of the fastening shoes. Adjust the displayed transducer distance (see section 11.6). Fix the transducers with the plastic screws on the transducer cable side of the fastening shoes.
- Place the fastening shoes/ruler assembly on the pipe at the measuring point. Insert the last ball into the slot on the upper side of one of the fastening shoe.
- Place the chain around the pipe.
- Tighten the chain and insert it into the other slot of the fastening shoe. Fix the second transducer in the same way.

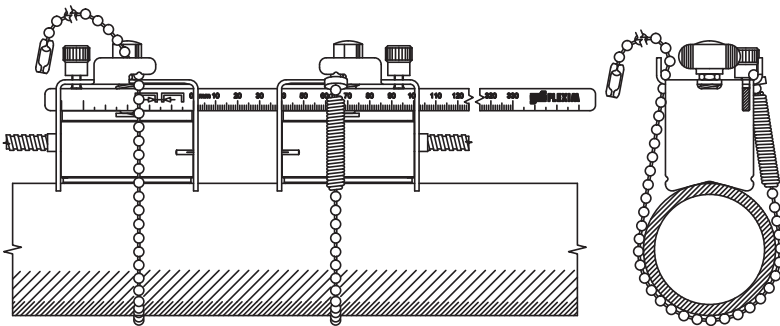

Fig. 8.3: Installation of the transducers with fastening shoes and chains

Extension of the ball chain

To extend the chain, insert the last ball of the extension into the fastening clip of the ball chain. The spare fastening clips supplied with the chain can be used to repair a broken chain.

8.5 Installation the Transducers with Magnetic Fastening Shoes

- Insert the transducers into the fastening shoes. Turn the screw on the upper side of the fastening shoes by 90° in order to engage and lock its extremity in the groove on top of the inserted transducer. Apply some coupling compound to the contact surface of the transducers.
- Insert the ruler into the lateral slot of the fastening shoes.
- Adjust the displayed transducer distance (see section 11.6). Fix the transducers with the plastic screws on the transducer cable side of the fastening shoes.
- Place the fastening shoe/ruler assembly on the pipe at the measuring point. There must be no air pockets between pipe wall and contact surface of the transducer. Adjust the transducer distance again.

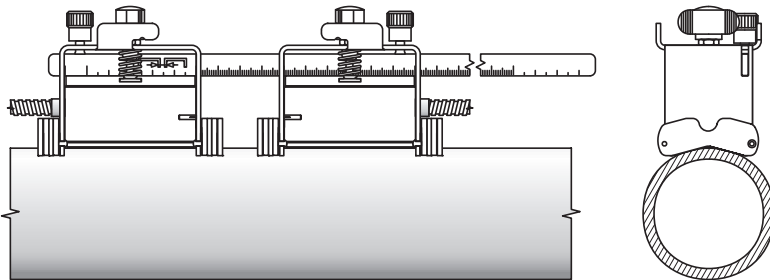

Fig. 8.4: Installation of the transducers with magnetic fastening shoes

8.6 Installation of the Transducers with Portable Variofix Rail with Chains

Normally, each transducer is mounted to its own Variofix rail. If the transducer distance is small and both transducers are on the same side of the pipe (reflection arrangement), they can be fixed in one Variofix rail.

Preparation and installation of the Variofix rail

- Adjustment of the Variofix rail to transducer width:
 - Loosen the 4 screws (1) for the adjustment of the rails (2) with a M8 wrench (see Fig. 8.5).
 - Place one transducer (3) in the center between the rails.
 - Press the two rails (2) together and tighten the 4 screws (1). The transducer can be shifted and removed.
 - Remove the transducer.
- Loosen the chain tensioners (4), but do not unscrew them completely.
- If the chain has not yet been mounted in the rail support (6):
Compress the spring of the chain tensioner (4) with the cylinder (7) while pushing the chain tensioner (4) in the horizontal groove (5) of the rail support (6).
- Place the Variofix rail on the pipe. Both rail supports (6) have to be completely supported by the pipe. Lay the ball chain (8) around the pipe (if the pipe is vertical, start with the upper ball chain).
- Press the chain tensioner (4) inside completely and push the ball chain (8) into the other groove (9) of the rail support.
- Fix the second ball chain (8) in the same way.
- Tension the ball chains (8) by tightening the chain tensioners (4).
- Repeat the steps if the second transducer is fixed to its own Variofix rail.

Installation of the transducer

- Force apart the legs of the spring clip (10) and clamp it over the outer side of the rails (2). The height where the spring clip will snap in depends on the height of the transducer.
- Apply some coupling compound to the contact surface of the transducer.
- Place the transducer between the rails (2). Observe the mounting direction (see Fig. 8.5).
- Push the spring clip (10) over the transducer until the knurled screw (11) is positioned over the blind hole of the transducer.
- Fix the transducer by tightening the knurled screw by hand (11).
- Repeat the steps for fixing the second transducer.
- Adjust the transducer distance by loosening the knurled screw (11) of a spring clip (10) and shifting the transducer.

1	screw	7	cylinder
2	rail	8	ball chain
3	transducer	9	groove
4	chain tensioner	10	spring clip
5	horizontal groove	11	knurled screw
6	rail support		

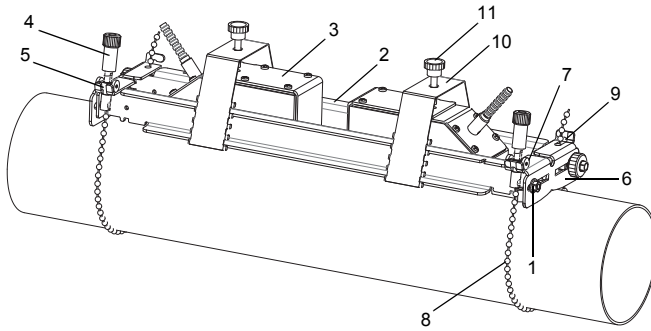

Fig. 8.5: Variofix rail with chains

9 Installation of the Temperature Probe (Optional)

Attention!	Observe the Safety Instructions for the Use in Explosive Atmosphere (FLUXUS F608**-A2: see document SIFLUXUS_608, FLUXUS F608**-F2: see document SIFLUXUS_608F2).
-------------------	---

9.1 Preparation of the Pipe

The pipe has to be stable. It has to be able to withstand the pressure exerted by the mounting fixture of the temperature probe.

A good thermal contact between pipe and temperature probe is obtained as follows:

- Clean the pipe at the selected measuring point:
 - Remove any insulation material, rust or loose paint.
 - If present, the paint layer has to be smoothed by sanding. The paint does not need to be removed completely.
- Use thermal conductivity foil or apply a layer of thermal conductivity paste or coupling compound to the contact surface of the temperature probe. Observe the corresponding operating temperature range.
- Observe that there must be no air pockets between the contact surface of the temperature probe and the pipe wall.

For the installation of the temperature probe (response time 50 s), see section 9.2. For the installation of the temperature probe (response time 8 s), see section 9.3.

9.2 Installation of the Temperature Probe (Response Time 50 s)

Note!	In case of great temperature differences, it is recommended to thermally insulate the temperature probe from the environment.
--------------	---

Select the installation instructions that correspond to the supplied clasp:

- for the installation with a clasp see section 9.2.1
- for the installation with a FLEXIM clasp see section 9.2.2
- for the installation with a quick release clasp see section 9.2.3

9.2.1 Installation with a Clasp

- Cut the tension strap to length (pipe circumference + at least 120 mm).
- Make sure that part (2) of the clasp is on top of part (1) (see Fig. 9.1 a). The hooks of part (2) have to be on the outer side of the clasp.
- Pull approx. 2 cm of the tension strap through the slot of the clasp to fix the clasp to the tension strap (see Fig. 9.1 b).
- Bend the end of the tension strap.
- Position the temperature probe on the pipe (see Fig. 9.2).
- Place the tension strap around the temperature probe and the pipe.
- Insert the tension strap through the parts (2) and (1) of the clasp.
- Pull the tension strap firmly and engage it in the inner hooks of the clasp.
- Tighten the screws of the clasps.



Fig. 9.1: Clasp

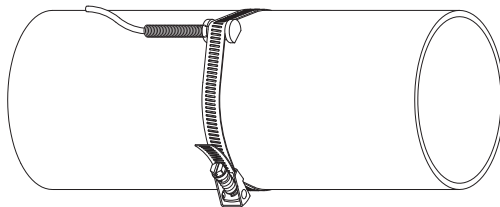

Fig. 9.2: Temperature probe on the pipe

9.2.2 Installation with a FLEXIM Clasp

- Cut the tension strap to length (pipe circumference + at least 120 mm).
- Insert approx. 2 cm of the tension strap into the slot of the clasp (see Fig. 9.3).
- Bend the end of the tension strap.
- Position the temperature probe on the pipe (see Fig. 9.2).
- Place the tension strap around the temperature probe and the pipe.

- Insert the tension strap through the parts (2) and (1) of the clasp.
- Pull the tension strap firmly and engage it in the inner hooks of the clasp.
- Tighten the screws of the clasp.

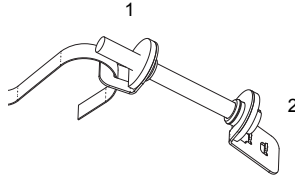

Fig. 9.3: FLEXIM clasp

9.2.3 Installation with a Quick Release Clasp

- Cut the tension strap to length (pipe circumference + at least 120 mm).
- Position the temperature probe on the pipe (see Fig. 9.2).
- Place the tension strap around the temperature probe and the pipe.
- Insert the tension strap into the clasp (see Fig. 9.4).
- Tighten the tension strap.
- Tighten the screw of the clasp.

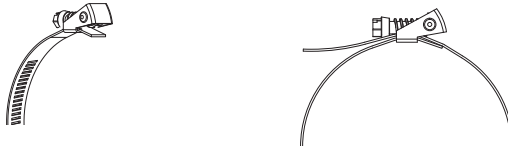

Fig. 9.4: Quick release clasp

9.3 Installation of the Temperature Probe (Response Time 8 s)

- Fix the protection plate and the insulation foam to the temperature probe (see Fig. 9.5).
- Take the spring end of the chain and insert the first ball into one of the slots on the upper side of the temperature probe (see Fig. 9.6).
- Place the chain around the pipe. Tighten the chain and insert it into the other slot of the temperature probe.

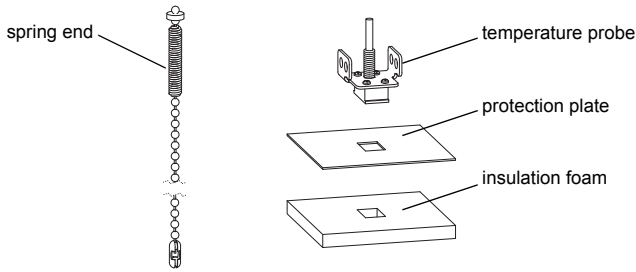

Fig. 9.5: Temperature probe

Note!

The entire contact surface of the temperature probe always has to rest on the pipe. In case of very small pipes, the protection plate and the insulation foam have to be cut to size, if necessary.

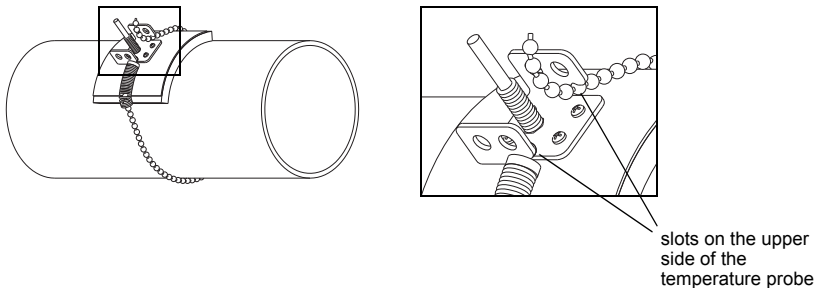

Fig. 9.6: Clasp

9.4 Connection of the Temperature Probe

Attention!

Observe the Safety Instructions for the Use in Explosive Atmosphere (FLUXUS F608**-A2: see document SIFLUXUS_608, FLUXUS F608**-F2: see document SIFLUXUS_608F2).

Connect the temperature probe to the temperature input of the transmitter (see Fig. 9.7 or Fig. 9.8 or Fig. 9.9 and Tab. 9.1).

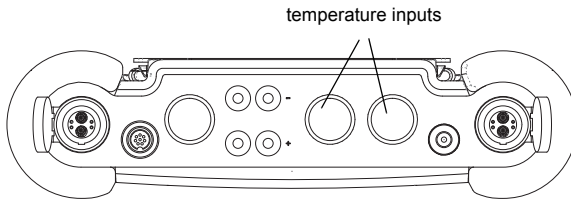

Fig. 9.7: Connections of the transmitter FLUXUS F601

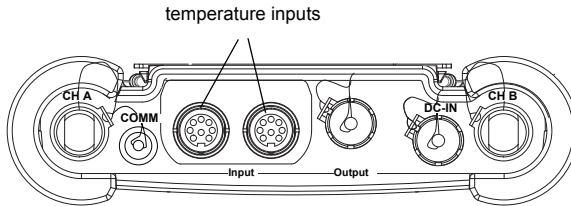

Fig. 9.8: Connections of the transmitter FLUXUS F608**-A2

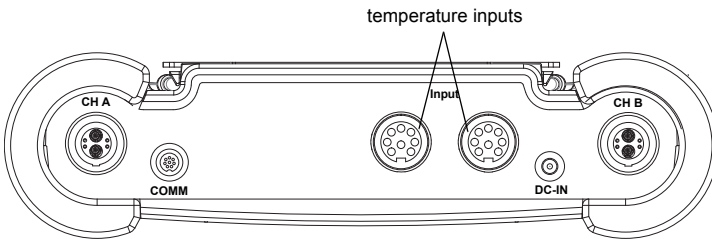
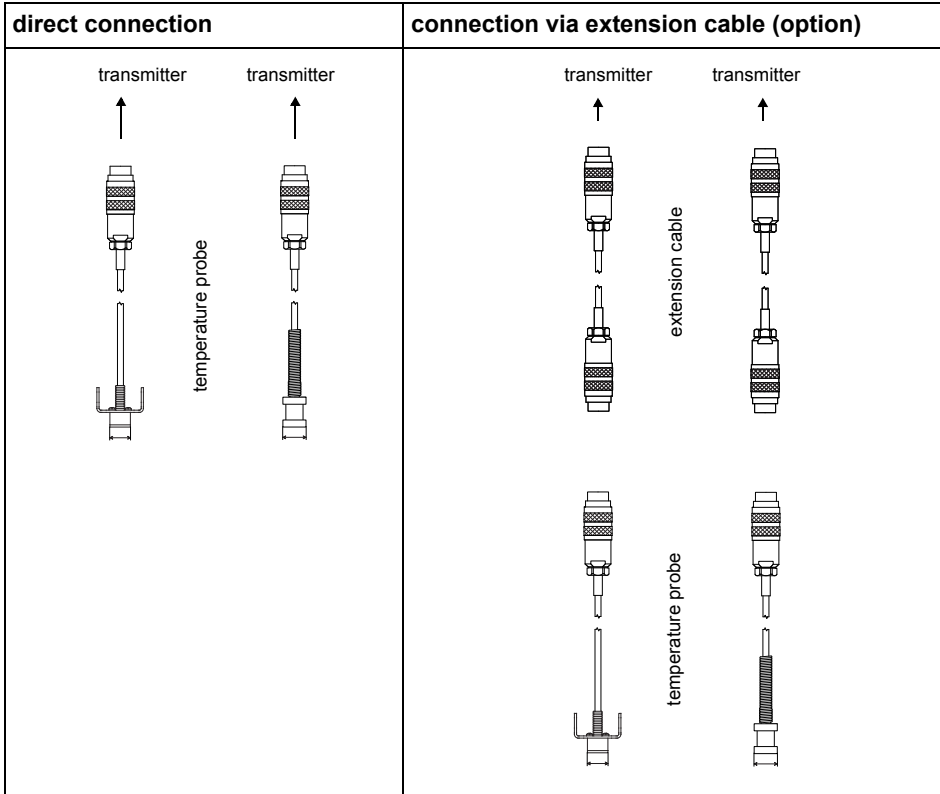

Fig. 9.9: Connections of the transmitter FLUXUS F608**-F2

Tab. 9.1: Connection of the temperature probe



• For the pin assignment of the temperature probe and the extension cable see Tab. 9.2 and Fig. 9.10.

Tab. 9.2: Pin assignment

terminal	temperature probe	extension cable
1	white/blue	blue
2	red/blue	gray
3,4,5	not connected	not connected
6	red	red
7	white	white
8	not connected	not connected

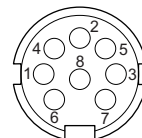

Fig. 9.10: Pins

10 Start-Up of the Transmitter

10.1 Switching on/off

```
FLEXIM FLUXUS
F60X-XXXXXXX
```

Press key C to switch on the transmitter.

After switching on it will be displayed which transducer has been detected at which measuring channel.

Afterwards, the serial number of the transmitter is displayed for a short time.

Data cannot be entered while the serial number is displayed.

```
>PAR<mea opt sf
Parameter
```

Afterwards, the main menu is displayed in the default language. The language of the display can be set (see section 10.5).

Press key BRK three times to switch off the transmitter.

10.2 Initialization

During an initialization (INIT) of the transmitter, the settings in the program branches `Parameter` and `Output Options` and some of the settings in the program branch `Special Funct.` are reset to the default settings of the manufacturer. For INIT-resistant settings, see annex A.

Proceed as follows to execute an initialization:

- While switching on the transmitter: keep keys BRK and C pressed.
- During the operation of the transmitter: press keys BRK, C and ENTER at the same time. A RESET is executed. Release only key ENTER. Keep keys BRK and C pressed.

```
INITIALISATION
----DONE----
```

After the initialization has been executed, the message `INITIALISATION DONE` is displayed.

After the initialization, the remaining settings of the transmitter can be reset to the default settings and/or the stored measured values can be deleted.

```
FACTORY DEFAULT?
no >YES<
```

Select `yes` to reset the remaining settings to the default settings or `no` to keep them at the current settings.

Press ENTER.

If `yes` is selected, the message `FACTORY DEFAULT DONE` will be displayed.

```

Delete Meas.Val.
no                >YES<

```

Select `yes` to delete the stored measured values or `no` to keep them stored.

Press ENTER.

This display will only be indicated if measured values are stored in the data logger.

10.3 Display

10.3.1 Main Menu

```

>PAR< mea opt sf
Parameter

```

The main menu contains the following program branches:

- `par` (Parameter)
- `mea` (Measuring)
- `opt` (Output Options)
- `sf` (Special Function)

The selected program branch is displayed in capital letters between arrows. The complete designation of the selected program branch is displayed in the lower line.

Select a program branch with key `<4>` and `<6>`. Press ENTER.

Note!	By pressing key BRK, the measurement is stopped and the main menu is selected.
--------------	--

Note!	In this user manual, all program entries and keys are indicated with typewriter characters (<code>Parameter</code>). The menu items are separated from the main menu by a backslash " <code>\</code> ".
--------------	---

10.3.2 Program Branches

- **Program branch `Parameter`**
input of the pipe and fluid parameters
- **Program branch `Measuring`**
processing of the steps for the measurement
- **Program branch `Output Options`**
setting of the physical quantity, the unit of measurement and the parameters for the transmission of measured value
- **Program branch `Special Funct.`**
contains all functions that are not directly related to the measurement

For an overview of the program branches see figure below. For a detailed overview of the menu structure see annex A.

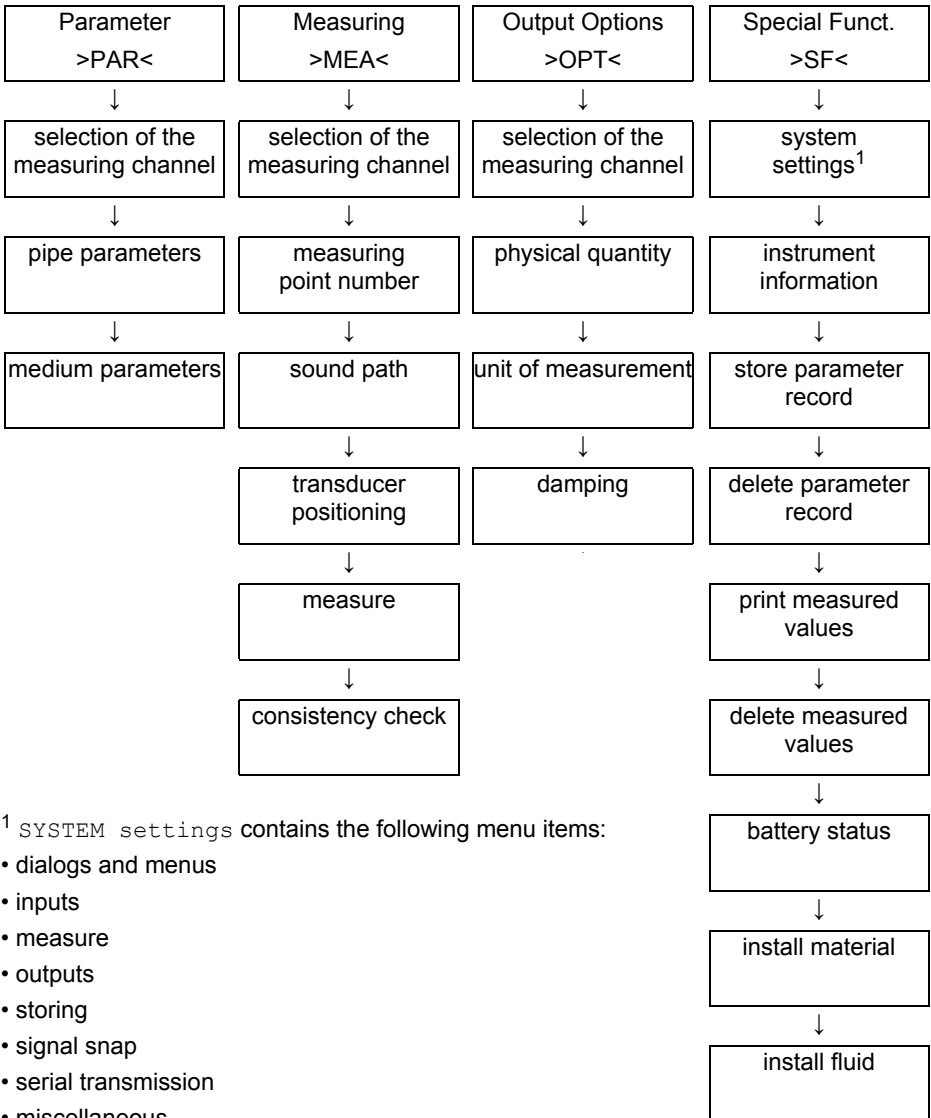

¹ SYSTEM settings contains the following menu items:

- dialogs and menus
- inputs
- measure
- outputs
- storing
- signal snap
- serial transmission
- miscellaneous
- set clock
- libraries

10.3.3 Navigation

If a vertical arrow (↓) is displayed, the menu item contains a scroll list. The current list item is displayed in the lower line.



Press key **8** and **2** to scroll and select a list item in the lower line. Press ENTER.

Some menu items contain a horizontal scroll list in the lower line. The selected list item is displayed in angle brackets and capital letters.

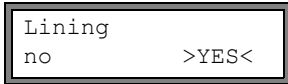

Press key **4** and **6** to scroll and select a list item in the lower line. Press ENTER.

Some menu items contain a horizontal scroll list in the upper line. The selected list item is displayed in capital letters and in angle brackets. The current value of the list item is displayed in the lower line.

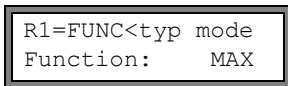

Press key **4** and **6** to scroll and select a list item in the upper line.

Press key **8** and **2** to scroll through the lower line and select a value for the selected list item.

Press ENTER.

10.4 HotCodes

A HotCode is a key sequence that activates certain functions and settings:

function	HotCode	see section	deactivation
language selection	9090xx	10.5	
enabling the FastFood mode	007022	13.7.1	HotCode 007022
manual input of the lower limit for the inner pipe diameter	071001	13.9	
activation of the SuperUser mode	071049	18.1	switching off the transmitter
change of the transmission parameters of the RS232 interface	232-0-	14.2.4	
activation of the BTU mode	007025	20.3.1	HotCode 007025
resetting the contrast of the display to medium	555000	17.4	

A HotCode can only be entered in the main menu immediately after the transmitter has been switched on. The HotCode is not displayed during the input.

10.5 Language Selection

The transmitter can be operated in the languages listed below. The language can be selected with the following HotCodes:

Tab. 10.1: Language HotCodes

909031	Dutch
909033	French
909034	Spanish
909044	English
909049	German

Depending on the technical data of the transmitter, some of the languages might not be implemented.

When the last digit has been entered, the main menu is displayed in the selected language.

The selected language remains activated when the transmitter is switched off and on again. After an initialization of the transmitter, the language is reset to the default language.

11 Basic Measurement

Attention! Observe the Safety Instructions for the Use in Explosive Atmosphere (see document SIFLUXUS_608).

The pipe and fluid parameters are entered for the selected measuring point (see chapter 5). The parameter ranges are limited by the technical characteristics of the transducers and the of transmitter.

Note! During the parameter input, the transducers have to be connected to the transmitter.

Note! The parameters will only be stored when the program branch `Parameter` has been edited in its entirety.

11.1 Input of the Pipe Parameters

```
>PAR<mea opt sf
Parameter
```

Select the program branch `Parameter`. Press ENTER.

```
Parameter      ↑
for Channel    A:
```

Select the channel for which the parameters are to be entered. Press ENTER.

This display will not be indicated if the transmitter has only one measuring channel.

If `Parameter from:` is displayed, at least one parameter record can be stored and can be selected. Each parameter record comprises all data necessary for a measurement:

- pipe parameters
- fluid parameters
- transducer parameters
- output options

A parameter record can be defined for each measuring task (see chapter 15).

11.1.1 Outer Pipe Diameter/Pipe Circumference

```
Outer Diameter
  100.0      mm
```

Enter the outer pipe diameter. Press ENTER.

```
Outer Diameter
 1100.0     MAXIMAL
```

An error message will be displayed if the entered parameter is not within the range. The limit is displayed.

example: upper limit 1100 mm for the connected transducers and for a pipe wall thickness of 50 mm

It is possible to enter the pipe circumference instead of the outer pipe diameter (see section 17.2.1).

If the input of the pipe circumference is activated and 0 (zero) is entered in `Outer Diameter`, the menu item `Pipe Circumfer.` will be displayed. If the pipe circumference is not to be entered, press key BRK to return to the main menu and start the parameter input again.

11.1.2 Pipe Wall Thickness

Wall Thickness
3.0 mm

Enter the pipe wall thickness. Press ENTER.

Note!

The inner pipe diameter (= outer pipe diameter - 2x pipe wall thickness) is calculated internally. If the value is not within the inner pipe diameter range of the connected transducers, an error message will be displayed.

It is possible to change the lower limit of the inner pipe diameter for a given transducer type (see section 13.9).

11.1.3 Pipe Material

The pipe material has to be selected to be able to determine the sound speed. The sound speed for the materials in the scroll list are stored in the transmitter.

Pipe Material ↓
Carbon Steel

Select the pipe material.

If the material is not in the scroll list, select `Other Material`. Press ENTER.

It can be specified which materials will be shown in the scroll list (see section 16.5).

When the pipe material has been selected, the corresponding sound speed is set automatically. If `Other Material` is selected, the sound speed has to be entered.

c-Material
3230.0 m/s

Enter the sound speed of the pipe material. Press ENTER.

Note!

Enter the sound speed of the material (i.e. longitudinal or transversal speed) which is nearer to 2500 m/s.

For the sound speed of some materials see annex C.1.

11.1.4 Pipe Lining

Lining	
no	>YES<

If the pipe has an inner lining, select `yes`. Press ENTER.
 If `no` is selected, the next parameter will be displayed (see section 11.1.5).

Lining	↓
Bitumen	

Select the lining material.
 If the material is not in the scroll list, select `Other Material`. Press ENTER.

It can be specified which materials will be shown in the scroll list (see section 16.5).
 If `Other Material` is selected, the sound speed has to be entered.

c-Material	
3200.0	m/s

Enter the sound speed of the lining material. Press ENTER.

For the sound speed of some materials see annex C.1.

Liner Thickness	
3.0	mm

Enter the thickness of the liner. Press ENTER.

Note! The inner pipe diameter (= outer pipe diameter - 2x pipe wall thickness - 2x liner thickness) is calculated internally. If the value is not within the inner pipe diameter range of the connected transducers, an error message will be displayed.

It is possible to change the lower limit of the inner pipe diameter for a given transducer type (see section 13.9).

11.1.5 Pipe Roughness

The flow profile of the fluid is influenced by the roughness of the inner pipe wall. The roughness is used for the calculation of the profile correction factor. As, in most cases, the pipe roughness cannot be determined exactly, it has to be estimated.

For the roughness of some materials see annex C.2.

Roughness	
0.4	mm

Enter the roughness of the selected pipe or liner material.
 Change the value according to the condition of the inner pipe wall. Press ENTER.

11.2 Input of the Fluid Parameters

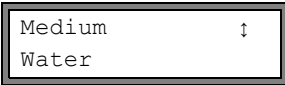

Select the fluid from the scroll list.

If the fluid is not in the scroll list, select `Other Medium`. Press ENTER.

It is possible to specify which fluids will be displayed in the scroll list (see section 16.5).

For the programmed parameters of common fluids see section C.3.

If a fluid is selected from the scroll list, the menu item for the input of the fluid temperature will be displayed directly (see section 11.2.4).

If `Other Medium` is selected, the fluid parameters have to be entered first:

- average sound speed of the fluid
- range around the average sound speed of the fluid
- kinematic viscosity
- density

11.2.1 Sound Speed

The sound speed of the fluid is used for the calculation of the transducer distance at the beginning of the measurement. However, the sound speed does not influence the measuring result directly. Often, the exact value of the sound speed for a fluid is unknown. Therefore, a range of possible values for the sound speed has to be entered.

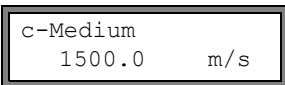

Enter the average sound speed of the fluid. Press ENTER.

This display will only be indicated if `Other Medium` is selected.

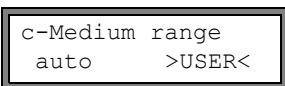

Select `auto` or `user`. Press ENTER.

`auto`: The area around the average sound speed is defined by the transmitter.

`user`: The area around the average sound speed has to be entered.

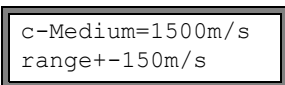

Enter the range around the average sound speed of the fluid. Press ENTER.

This display will only be indicated if `user` is selected.

11.2.2 Kinematic Viscosity

The kinematic viscosity influences the flow profile of the fluid. The entered value and further parameters are used for the profile correction.

```
Kinem.Viscosity
  1.00 mm2/s
```

Enter the kinematic viscosity of the fluid. Press ENTER.

This display will only be indicated if `Other Medium` is selected.

11.2.3 Density

The density is used to calculate the mass flow (product of the volumetric flow rate and the density).

Note!

If the mass flow is not measured, press ENTER. The other measuring results will not be affected.

```
Density
  1.00 g/cm3
```

Enter the operating density of the fluid. Press ENTER.

This display will only be indicated if `Other Medium` is selected.

11.2.4 Fluid Temperature

The fluid temperature is used for the interpolation of the sound speed and therefore for the calculation of the recommended transducer distance at the beginning of the measurement.

During the measurement, the fluid temperature is used for the interpolation of the density and viscosity of the fluid.

The value entered here is used for the calculations if the fluid temperature is not measured and fed into the transmitter via an input.

```
Medium Temperat.
  20.0 C
```

Enter the fluid temperature. The value has to be within the operating temperature range of the transducers. Press ENTER.

11.2.5 Fluid Pressure

The fluid pressure is used for the interpolation of the sound speed.

```
Fluid pressure
  1.00 bar
```

Enter the fluid pressure. Press ENTER.

This display will only be indicated if `Special Funct.\SYSTEM settings\Dialogs\Menu\Fluid pressure` is activated.

11.3 Other Parameters

11.3.1 Transducer Parameters

If transducers are detected at a measuring channel, input of parameters will be finished. Press ENTER. The main menu will be displayed.

If no or special transducers are connected, the transducer parameters have to be entered.

```
Transducer Type↑
Standard
```

Select `Standard` to use the standard transducer parameters stored in the transmitter.

Select `Special Version` to enter the transducer parameters. The transducer parameters have to be provided by the manufacturer.

Press ENTER.

Note!

If standard transducer parameters are used, FLEXIM cannot guarantee for the precision of the measured values. A measurement might even be impossible.

```
Transd. Data 1
35.99
```

If `Special Version` is selected, enter the 6 transducer parameters specified by the manufacturer. Press ENTER after each input.

11.4 Selection of the Channels

The channels on which the measurement is conducted can be activated individually.

```
par>MEA<opt sf
Measuring
```

Select the program branch `Measuring`. Press ENTER.

```
par>MEA<opt sf
NO DATA!
```

If this error message is displayed, the parameters are not complete. Enter the missing parameters in the program branch `Parameter`.

```
CHANN: >A< B Y Z
MEASUR  ✓ ✓ - .
```

The channels for the measurement can be activated and deactivated.

✓: the channel is active

-: the channel is not active

•: the channel cannot be activated

This display will not be indicated if the transmitter has only one measuring channel.

Note!

A channel cannot be activated if the parameters are not valid, e.g., if the parameters in the program branch `Parameter` of the channel are not complete.

- Select a channel with the key `<4>` and `<6>`
- Press key `<8>` to activate or deactivate the selected channel. Press ENTER.

A deactivated channel will be ignored during the measurement. The parameters entered for this channel will remain unchanged.

If the data logger or the serial interface is activated, the measuring point number has to be entered:

```
A:Meas.Point No.:
  xxx (↑↓← →)
```

Enter the measuring point number. Press ENTER.

If arrows are displayed in the lower line on the right, ASCII text can be entered. If no arrows are displayed, only digits, point and hyphen can be entered.

11.5 Defining the Number of Sound Paths

```
A: Sound Path
  2      NUM
```

A value for the number of sound paths corresponding to the connected transducers and the entered parameters are recommended. Change the value, if necessary. Press ENTER.

For the definition of the sound paths see section 3.3.

11.6 Transducer Distance

```
Transd. Distance
A:53.9 mm Reflec
```

A value for the transducer distance is recommended. Fix the transducers (see section chapter 8). Adjust the transducer distance.

Press ENTER.

A - measuring channel

Reflec - reflection arrangement

Diagon - diagonal arrangement

The transducer distance is the distance between the inner edges of the transducers (see section 3.3).

In case of a measurement in diagonal mode on very small pipes, a negative transducer distance is possible.

Note!

The accuracy of the recommended transducer distance depends on the accuracy of the entered pipe and fluid parameters.

11.6.1 Fine Adjustment of the Transducer Distance

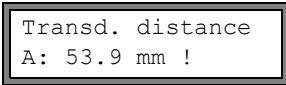

If the displayed transducer distance is adjusted, press ENTER.

The measuring for the positioning of the transducers is started.

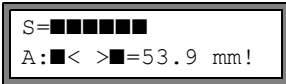

The amplitude of the received signal is displayed by the bar graph S=.

If the LED of the measuring channel lights green, the signal is sufficient for a measurement.

If the LED of the measuring channel lights red, the signal is not sufficient for a measurement.

- Shift a transducer slightly within the range of the recommended transducer distance until the LED of the measuring channel lights green.



The following quantities can be displayed in the upper line by pressing key [9] and in the lower line by pressing key [3]:

- ■<>■=: transducer distance
- time: Transit time of the measuring signal in μ s
- S=: signal amplitude
- Q=: signal quality, bar graph has to have max. length

If the signal is not sufficient for measurement, Q= UNDEF will be displayed.

In case of large deviations, check if the entered parameters are correct or repeat the measurement at a different point on the pipe.

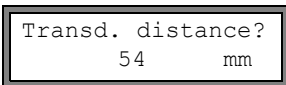

After the precise positioning of the transducers, the recommended transducer distance is displayed again.

Enter the actual (precise) transducer distance. Press ENTER.

Repeat the steps for all channels on which a measurement is being made. The measurement will be started automatically.

11.6.2 Consistency Check

If a wide range for the sound speed has been entered in the program branch `parameter` or the exact parameters of the fluid are unknown, a consistency check is recommended.

The transducer distance can be displayed during the measurement by scrolling the key

9.

L=(50.0) 54.0 mm
54.5 m3/h

The optimum transducer distance is displayed in brackets (here: 50.0 mm) in the upper line, followed by the entered transducer distance (here: 54.0 mm). The latter value has to correspond to the adjusted transducer distance.

The optimum transducer distance is calculated on the basis of the measured sound speed. It is therefore a better approximation than the first recommended value which had been calculated on the basis of the sound speed range entered in the program branch `parameter`.

If the difference between the optimum and the entered transducer distance is less than specified in Tab. 11.1, the measurement is consistent and the measured values are valid. The measurement can be continued.

If the difference is greater, adjust the transducer distance to the displayed optimum value. Afterwards, check the signal quality and the signal amplitude bar graph (see section 11.6.1). Press ENTER.

Tab. 11.1: Standard values for signal optimization

transducer frequency (third character of the technical type)	difference between the optimum and the entered transducer distance [mm]	
	shear wave transducer	Lamb wave transducer
G	20	-45...+90
H	-	-30...+60
K	15	-20...+40
M	10	-10...+20
P	8	-5...+10
Q	6	-3...+5
S	3	-

```
Transd. distance?
  50.0      mm
```

Enter the new adjusted transducer distance. Press ENTER.

```
L=(51.1) 50.0 mm
  54.5      m3/h
```

Press key again to scroll until the transducer distance is displayed and check the difference between optimum and entered transducer distance. Repeat the steps, if necessary.

Note!

If the transducer distance is changed during the measurement, the consistency check will have to be repeated.

Repeat the steps for all channels on which a measurement is being made.

11.6.3 Value of the Sound Speed

The sound speed of the fluid can be displayed during the measurement by pressing key .

If an approximate range for the sound speed has been entered in the program branch `parameter` and the transducer distance has been optimized afterwards as described in section 11.6.2, it is recommended to write down the sound speed for the next measurement. By doing this, it will not be necessary to repeat the fine adjustment.

Also write down the fluid temperature because the sound speed depends on the temperature. The value can be entered in the program branch `parameter` or a user defined fluid can be created for this sound speed (see section 16.2 and 16.3).

11.7 Start of the Measurement

```
A:Volum. flow rate
  31.82      m3/h
```

The measured values are displayed in the lower line. Press ENTER to return to the fine adjustment of the transducer distance (see section 11.6.1).

If more than one measuring channel is available/activated, the transmitter works with an integrated measuring point multiplexer providing simultaneous measurement on the different measuring channels.

The flow rate is measured on one measuring channel for approx. 1 s, then the multiplexer switches to the next activated channel.

The time necessary for the measurement depends on the measuring conditions. E.g., if the measuring signal cannot be detected immediately, the measurement duration might be > 1 s.

The outputs and the serial interface continuously receive the measured values of the corresponding channel. The results are displayed according to the currently selected output options. The default unit of measurement of the volumetric flow rate is m^3/h . For the selection of the values to be displayed and for the setting of the output options see chapter 12. For further measuring functions see chapter 13.

11.8 Detection of the Flow Direction

The flow direction in the pipe can be detected with the help of the displayed volumetric flow rate in conjunction with the arrow on the transducers:

- The fluid flows in the direction of the arrow if the displayed volumetric flow rate is positive (e.g., 54.5 m³/h).
- The fluid flows against the arrow direction if the displayed volumetric flow rate is negative (e.g., -54.5 m³/h).

11.9 Stopp the Measurement

A measurement is stopped by pressing key BRK.

Note!	Be careful not to stop a current measurement by inadvertently pressing key BRK!
--------------	---

12 Displaying the Measured Values

The physical quantity is set in the program branch `Output Options` (see section 12.1). During the measurement, the designation of the physical quantity is displayed in the upper line, the measured value in the lower line. The display can be adapted (see section 12.3).

12.1 Selection of the Physical Quantity and of the Unit of Measurement

The following physical quantities can be measured:

- sound speed
- flow velocity: is calculated on the basis of the measured transit time difference
- volumetric flow rate: is calculated by multiplying the flow velocity by the cross-sectional pipe area
- mass flow rate: is calculated by multiplying the volumetric flow rate by the operating density of the fluid
- heat flow (optional): is calculated on the basis of the volumetric flow rate, the measured temperatures of the supply and return lines, and the heat flow coefficients of the fluid

The physical quantity is selected as follows:

```
par mea >OPT< sf
Output Options
```

Select the program branch `Output Options`. Press `ENTER`.

```
Output Options ↓
for Channel A:
```

Select the channel for which the physical quantity is to be entered. Press `ENTER`.

This display will not be indicated if the transmitter has only one measuring channel.

```
Physic. Quant. ↓
Volume flow
```

Select the physical quantity in the scroll list. Press `ENTER`.

```
Volume in:      ↓
m3/h
```

For the selected physical quantity (except for the sound speed), a scroll list with the available units of measurement is displayed. The unit of measurement which was selected previously is displayed first.

Select the unit of measurement of the selected physical quantity. Press `ENTER`.

Press key `BRK` to return to the main menu. The further displays of the program branch `Output Options` are for the activation of the transmission of measured value.

Note!

If the physical quantity or the unit of measurement is changed, the settings of the outputs will have to be checked (see chapter 22).

12.2 Toggling between the Channels

If more than one channel is available/activated, the display for the measured values can be adapted as follows:

- AutoMux mode
 - all channels
 - only calculation channels
- HumanMux mode

The key toggles between the modes.

12.2.1 AutoMux Mode

In the AutoMux mode, the display and the measuring process are synchronized. The channel on which a measurement is being made is displayed in the upper line on the left.

The measured values are displayed as configured in the program branch *Output Options* (see section 12.1). When the multiplexer switches to the next channel, the display is updated.

```
A:Volume flow
  54.5    m3/h
```

```
B:Flow Velocity
  1.25    m/s
```

The default is the AutoMux mode. The AutoMux mode will be activated after an initialization of the transmitter.

All channels

The measured values of all channels (measuring and calculation channels) are displayed. The next active channel is selected after min. 1.5 s.

Only calculation channels

Only the measured values of the calculation channels are displayed. The next active calculation channel is displayed after min. 1.5 s.

This mode can only be activated if at least 2 calculation channels are active.

12.2.2 HumanMux Mode

In the HumanMux mode, the measured values of one channel are displayed. The measurement on the other channels is continued, but not displayed.

```
B:Flow Velocity
  1.25    m/s
```

The selected channel is displayed left in the upper line.

Press key to display the next activated channel. The measured values of the selected channel will be displayed as configured in the program branch *Output Options* (see section 12.1).

12.3 Adjustment of the Display

During the measurement, the display can be adapted as to display two measured values simultaneously (one in each line of the display). This does not affect totalizing, storing of measured values, transmission of the measured values, etc.

The following information can be displayed in the upper line:

display	explanation
BATT=	charge state of the battery
Mass Flow=	designation of the physical quantity
A: +8.879 m ³	values of the totalizers, if activated
Tx=	temperatures assigned to the channel and their difference if the temperature is measured
full=	date and time at which the data logger will be full, if activated
Mode=	measuring mode
L=	transducer distance
Rx=	alarm state indication if it is activated (see section 22.8.5) and if alarm outputs are activated (see section 22.8).
$\delta c=$	difference between the measured sound speed and the sound speed of a selected reference fluid, if activated (see section 17.3)
	status line (see section 12.4)

The measured values of the physical quantity selected in the program branch **Output Options** can be displayed in the lower line:

display	explanation
12.3 m/s	flow velocity
1423 m/s	sound speed
124 kg/h	mass flow rate
15 m ³ /h	volumetric flow rate
12 kW	heat flow rate

Press key during the measurement to change the display in the upper line, press key to change the display in the lower line.

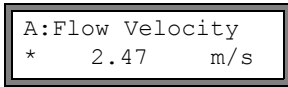

The character * indicates that the displayed value (here: flow velocity) is not the selected physical quantity.

12.4 Status Line

Important data on the ongoing measurement are shown in the status line. The quality and precision of the ongoing measurement can be estimated.

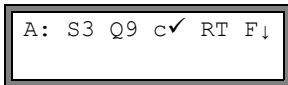

Press key during the measurement to scroll through the upper line to the status line.

	value	meaning
S	0	signal amplitude < 5 %

	9	≥ 90 %
Q	0	signal quality < 5 %

	9	≥ 90 %
c		sound speed comparison of the measured and the expected sound speed of the fluid. The expected sound speed is calculated on the basis of the fluid parameters (fluid selected in the program branch <i>Parameter</i> , temperature dependence, pressure dependence).
	√	ok, is equal to the expected value
	↑	> 20 % of the expected value
	↓	< 20 % of the expected value
	?	unknown, cannot be measured

	value	meaning
R		flow profile information about the flow profile based on the Reynolds number
	T	fully turbulent flow profile
	L	fully laminar flow profile
	↓	the flow is in the transition range between laminar and turbulent flow
	?	unknown, cannot be calculated
F		flow velocity comparison of the measured flow velocity with the flow limits of the system
	√	ok, the flow velocity is not in the critical range
	↑	the flow velocity is higher than the current limit
	↓	the flow velocity is lower than the current cut-off flow (even if it is not set to zero)
	0	the flow velocity is in the offset range of the measuring method
	?	unknown, cannot be measured

12.5 Transducer Distance

$L = (51.2) \ 50.8 \text{ mm}$ $54.5 \quad \text{m}^3/\text{h}$
--

By pressing key 9 during the measurement, it is possible to scroll to the display of the transducer distance.

The optimum transducer distance (here: 51.2 mm) will be displayed in parentheses in the upper line, followed by the entered transducer distance (here: 50.8 mm).

The optimum transducer distance might change during the measurement (e.g., due to temperature fluctuations).

A deviation from the optimum transducer distance (here: -0.4 mm) will be compensated internally.

Note!

Never change the transducer distance during the measurement!

13 Advanced Measuring Functions

13.1 Damping Factor

Each displayed measured value is the floating average of all measured values of the last x seconds, where x is the damping factor. A damping factor of 1 s means that the measured values are not averaged as the measuring rate is approx 1/s.

The default value of 10 s is appropriate for normal flow conditions. Values which fluctuate strongly due to of a higher flow dynamic, require a higher damping factor.

Select the program branch `Output Options`. Press ENTER until the menu item `Damping` is displayed.

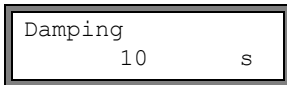

Enter the damping factor. Press ENTER.

Press key BRK to return to the main menu.

13.2 Totalizer

Heat quantity, total volume or total mass of the fluid at the measuring point can be determined.

There are two flow totalizers, one for the positive flow direction, one for the negative flow direction. The unit of measurement used for totalizing corresponds to the heat, volume or mass unit selected for the physical quantity.

The value of a totalizer consists of max. 11 digits, including max. 4 decimal places. For the adjustment of the number of decimal places see section 18.7.

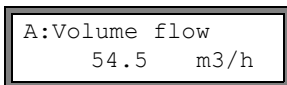

To activate the totalizers, press key `8` during measurement (see Tab. 13.1).

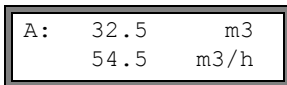

The value of the totalizer will be displayed in the upper line (here: the volume which has passed through the pipe at the measuring point in the positive flow direction after the activation of the totalizers).

Tab. 13.1: Keys for display of the totalizers

activation	press key <code>8</code> during the measurement
deactivation	press key <code>2</code> three times during measurement
display of the flow totalizer for the positive flow direction	press key <code>6</code> during the measurement
display of the flow totalizer for the negative flow direction	press key <code>4</code> during the measurement

Tab. 13.1: Keys for display of the totalizers

reset of the totalizers to Zero	press key  three times during measurement
---------------------------------	--

Selection of the flow totalizers for storing

```
A:NO COUNTING !
      3.5      m/s
```

This error message will be displayed if the flow totalizers of a measuring channel used for measuring the flow velocity are to be activated. The flow velocity cannot be totalized.

Note! The flow totalizers can only be activated for the measuring channel whose measured values are displayed at the moment.

Note! The pressing of a key will only influence the flow totalizers if the flow totalizer is displayed in the upper line.

It is possible to store only the value of the flow totalizer that is currently displayed or one value for each flow direction. Select `Special Funct.\SYSTEM settings\Storing\Quantity Storage`.

```
Quantity Storage
one      >BOTH<
```

If `one` is selected, only the value of the totalizer that is currently displayed will be stored.

If `both` is selected, the values of the totalizers totalizer for both flow directions will be stored.

Press ENTER.

When the measurement is stopped

The behavior of the totalizers when the measurement is stopped or after a RESET of the transmitter is set in `Special Funct.\SYSTEM settings\Measuring\Quantity recall`.

```
Quantity recall
off      >ON<
```

If `on` is selected, the values of the flow totalizers will be stored and used for the next measurement.

If `off` is selected, the flow totalizers will be reset to zero.

During the heat flow measurement

During the heat flow measurement, it is possible to output and store the values of the heat quantity totalizer and of the volume totalizer. Select `Special Funct.\SYSTEM settings\Measuring\heat+flow quant..`

```
heat+flow quant.
off                >ON<
```

Select **on** to store and output the values of the heat quantity totalizer and the volume totalizer during the heat flow measurement.

Press ENTER.

13.2.1 Overflow of the Flow Totalizers

The overflow behavior of the flow totalizers can be set:

Without overflow:

- The value of the totalizer increases to the internal limit of 10^{38} .
- The values will be displayed as exponential numbers ($\pm 1.00000E10$), if necessary. The flow totalizer can only be reset to zero manually.

With overflow:

- The flow totalizer will be reset to zero automatically when ± 9999999999 is reached.

Select Special Funct.\SYSTEM settings\Measuring\Quant. wrapping.

```
Quant. wrapping
off                >ON<
```

Select **on** to work with overflow. Select **off** to work without overflow. Press ENTER.

Independently of the setting, the flow totalizers can be reset to zero manually.

Note!

The overflow of a totalizer influences all output channels, e.g., data logger, online transmission of data.

The output of the sum of both totalizers (the throughput ΣQ) via an output will not be valid after the first overflow (wrapping) of one of the corresponding totalizers.

To signalize the overflow of a flow totalizer, an alarm output with the switching condition **QUANT.** and the type **HOLD** has to be activated.

13.3 Settings of the HybridTrek Mode

The HybridTrek mode combines the TransitTime mode and the NoiseTrek mode. During a measurement in the HybridTrek mode, the transmitter automatically toggles between the TransitTime mode and the NoiseTrek mode depending on the gaseous or solid content in the fluid in order to receive valid measuring values.

Note!

Due to its higher measuring accuracy, the TransitTime mode should be used preferentially over the NoiseTrek mode.

```
Enable NoiseTrek
off          >ON<
```

Select Special Funct.\SYSTEM settings\Measuring. Press ENTER until the list item `Enable NoiseTrek` is displayed. `NoiseTrek mode on` to enable the NoiseTrek mode, `off` to disable it. Press ENTER.

```
Auto NoiseTrek ?
no          >YES<
```

Select `no` to deactivate the automatic toggling between the `TransitTime` and the `NoiseTrek` mode. If `no` is selected, the `NoiseTrek` mode can only be activated and deactivated manually during the measurement.

Select `yes` to activate the automatic toggling between the `TransitTime` and the `NoiseTrek` mode. The `NoiseTrek` mode can also be activated and deactivated manually during the measurement if `yes` is selected.

Press ENTER.

This display will only be indicated if the `NoiseTrek` mode is enabled.

```
TT-Failed |After
→NoiseTrek | 40s
```

If the automatic toggling between the `TransitTime` and the `NoiseTrek` mode is activated, the toggling parameters have to be configured.

Enter the time after which the transmitter has to toggle to the `NoiseTrek` mode if there are no valid measured values in the `TransitTime` mode. If 0 (zero) is entered, the transmitter does not toggle to the `NoiseTrek` mode.

```
NT-Failed |After
→TransTime | 60s
```

Enter the time after which the transmitter has to toggle to the `TransitTime` mode if there are no valid measured values in the `NoiseTrek` mode. If 0 (zero) is entered, the transmitter does not toggle to the `TransitTime` mode.

If there are valid measured values in the `NoiseTrek` mode, the transmitter can periodically toggle to the `TransitTime` mode in order to check if a measurement in the `TransitTime` mode is possible again. The time interval and the duration of the checking are set as follows:

```
NT-Ok, but | Each
check TT   | 300s
```

Enter the time after which the transmitter has to toggle to the `TransitTime` mode. If 0 (zero) is entered, the transmitter does not toggle to the `TransitTime` mode.

```
Keep TT   | For
checking  | 5s
```

Enter the time after which the transmitter has to toggle to the `NoiseTrek` mode if there are no valid measured values in the `TransitTime` mode.

example:

TT-Failed →NoiseTrek: After 40s
 NT-Failed→TransTime: After 60s
 NT-Ok,but check TT: Each 300s
 Keep TT checking: For 5s

If no measurement is possible in the TransitTime mode for the duration of 40 s, the transmitter toggles to the NoiseTrek mode. If no measurement is possible in the NoiseTrek mode for the duration of 60 s, the transmitter toggles back to the TransitTime mode.

If there are valid measured values during the measurement in the NoiseTrek mode, the transmitter toggles to the TransitTime mode every 300 s. If no measurement is possible in the TransitTime mode for the duration of 5 s, the transmitter toggles back to the NoiseTrek mode. If a valid measured value is obtained in the TransitTime mode within the duration of 5 s, the transmitter continues the measurement in the TransitTime mode.

In order to toggle between the TransitTime mode and the NoiseTrek mode manually during the measurement, press key .

13.4 Upper Limit of the Flow Velocity

Single outliers caused by heavily disturbed surroundings can appear among the measured values of the flow velocity. If the outliers are not ignored, they will affect all derived physical quantities, which will then be unsuitable for the integration (e.g., pulse outputs). It is possible to ignore all measured flow velocities higher than a preset upper limit. These measured values will be marked as outliers.

The upper limit of the flow velocity is set in `Special Funct.\SYSTEM settings\Measuring\Velocity limit`.

Velocity limit
0.0 m/s

Enter 0 (zero) to switch off the checking for outliers.

Enter a limit > 0 to switch on the checking for outliers. The measured flow velocity will then be compared to the entered upper limit.

Press ENTER.

If the flow velocity is higher than the upper limit,

- the flow velocity will be marked as invalid. The physical quantity cannot be determined.
- the LED of the measuring channel will light red
- "!" will be displayed after the unit of measurement (in case of a normal error, "?" is displayed)

Note!

If the upper limit is too low, a measurement might be impossible because most of the measured values will be marked as "invalid".

13.5 Cut-Off Flow

The cut-off flow is a lower limit for the flow velocity. All measured flow velocities that are lower than the limit and their derived values are set to zero.

The cut-off flow can depend on the flow direction or not. The cut-off flow is set in `Special Funct.\SYSTEM settings\Measuring\Cut-off Flow`.

```
Cut-off Flow
absolut    >SIGN<
```

Select `sign` to define a cut-off flow in dependence on the flow direction. Two independent limits are set for the positive and negative flow directions.

Select `absolut` to define a cut-off flow independently of the flow direction. A limit is set for the absolute value of the flow velocity.

Press ENTER.

```
Cut-off Flow
factory    >USER<
```

Select `factory` to use the default limit of 2.5 cm/s (0.025 m/s) for the cut-off flow.

Select `user` to enter the cut-off flow.

Press ENTER.

If `Cut-off Flow\sign` and `user` are selected, two values will have to be entered:

```
+Cut-off Flow
   2.5    cm/s
```

Enter the cut-off flow. Press ENTER.

All positive values of the flow velocity that are lower than this limit will be set to zero.

```
-Cut-off Flow
  -2.5    cm/s
```

Enter the cut-off flow. Press ENTER.

All negative values of the flow velocity greater than this limit will be set to zero.

If `Cut-off Flow\absolut` and `user` is selected, only one value will have to be entered:

```
Cut-off Flow
   2.5    cm/s
```

Enter the cut-off flow. Press ENTER.

The absolute values of all flow velocity values that are lower than this limit will be set to zero.

13.6 Uncorrected Flow Velocity

For special applications, the uncorrected flow velocity might be of interest.

The profile correction for the flow velocity is activated in `Special Funct.\SYSTEM settings\Measuring\Flow Velocity`.

```
Flow Velocity
>NORMAL< uncorr.
```

Select `normal` to display and output the flow velocity with profile correction.

Select `uncorr.` to display the flow velocity without profile correction. Press ENTER.

```
A:PROFILE CORR.
>NO<           yes
```

If `uncorr.` is selected, it has to be confirmed each time the program branch `Measuring` is selected if the profile correction is to be used.

```
A:FLOW VELOCITY
  2.60      m/s
```

If `no` is selected, the profile correction will be switched off.

All physical quantities will be calculated with the uncorrected flow velocity.

During the measurement, the designation of the physical quantity will be displayed in capital letters to indicate that the value is uncorrected.

Press ENTER.

```
A:PROFILE CORR.
no           >YES<
```

If `yes` is selected, the uncorrected flow velocity will only be used if the flow velocity is selected as the physical quantity in the program branch `Output Options`.

All other physical quantities (volumetric flow rate, mass flow, etc.) will be determined with the corrected flow velocity.

During the measurement, the designation of the physical quantity will be displayed in capital letters to indicate that the value is uncorrected.

Press ENTER.

```
A:Flow Velocity
*U   54.5     m/s
```

In both cases, the corrected flow velocity can also be displayed.

Press key to scroll until the flow velocity is displayed. The uncorrected flow velocity is marked with `U`.

Uncorrected flow velocities transmitted to a PC are marked with `uncorr.`

13.7 Measurement of High Dynamic Flows (FastFood Mode)

The FastFood mode allows to measure flows with high dynamics.

A continuous adaptation to changing measuring conditions which takes place in the normal measuring mode is only partially realized in the FastFood mode.

- The sound speed of the fluid is not updated. The last measured value of the sound speed before toggeling to the FastFood mode is used.
- A change of measuring channel is not possible. In a multi-channel measurement, the measurement stops on all further channels during the activation of the FastFood mode.
- The outputs of the FastFood mode activated channel can still be used.
- Outputs for further channels (multi-channel measurement) are not updated.
- The measured values are stored with the storage rate of the FastFood mode (see section 13.7.2).
- The FastFood mode has to be enabled and activated.

13.7.1 Enabling/Disabling the FastFood Mode

Enter HotCode **007022** immediately after the transmitter has been switched on.

```
Enable FastFood
no                >YES<
```

Select `yes` to enable the FastFood Mode, `no` to disable it.

13.7.2 Storage Rate of the FastFood Mode

```
Storage Rate
70            ms
```

If the FastFood mode is enabled, a `Storage Rate` in `ms` will have to be entered in the program branch `Output Options`.

Press ENTER.

13.7.3 Activation/Deactivation of the FastFood Mode

If the FastFood mode is enabled and a measurement is started, the normal measuring mode will still be running (i.e. multi-channel measurement with permanent adaptation to the measuring conditions). If the data logger is activated, the measured values will not be stored.

```
A:Volume flow
54.5        m3/h
```

Press key `0` to activate/deactivate the FastFood mode for the measuring channel currently displayed.

```
A:Mode=FastFood
54.5        m3/h
```

Press key `9` to scroll through the upper line until the activated measuring mode `A:Mode=FastFood` or `A:Mode=TransTime` is displayed.

If the data logger is activated, a new data set will be created and storing of measured values will be started. If the FastFood mode is deactivated or if the measurement is interrupted, the storing will be stopped.

Note!

The values of the current series of measured values will be deleted if the FastFood mode is deactivated and activated again without interrupting the measurement.

The values of the current series of measured values will be kept if the measurement is interrupted before the FastFood mode is activated again. A new series of measured values is created when the next measurement is started.

13.8 Calculation Channels

In addition to the ultrasonic measuring channels, the transmitter has two virtual calculation channels Y and Z. The measured values of the measuring channels A and B can be calculated by means of the calculation channels.

The result of the calculation is the measured value of the selected calculation channel. This measured value is equivalent to the measured values of a measuring channel. All operations with the measured values of a measuring channel (totalizing, online transmission of data, storing, outputs, etc.) can also be done with the values of a calculation channel.

13.8.1 Characteristics of the Calculation Channels

In the program branch `Parameter`, the measuring channels to be used for the calculation and the calculation function have to be entered.

A calculation channel cannot be attenuated. The damping factor has to be set separately for each of the two measuring channels.

Two cut-off flow values for each calculation channel can be defined. The cut-off flow is not based on the flow velocity as for measuring channels. Instead, it is defined in the unit of measurement of the physical quantity selected for the calculation channel. During the measurement, the calculated values are compared to the cut-off flow values and set to zero if necessary.

A calculation channel provides valid measured values if at least one measuring channel provides valid measured values.

13.8.2 Parameterization of a Calculation Channel

```
Parameter      ↓
for Channel   Y:
```

Select a calculation channel (Y or Z) in the program branch `Parameter`. Press ENTER.

```
Calculation:
Y= A - B
```

The current calculation function is displayed. Press ENTER to edit the function.

```
>CH1< funct  ch2
↑
```

Three scroll lists are displayed in the upper line:

- selection of the first measuring channel (`ch1`)
- selection of the calculation function (`funct`)
- selection of the second measuring channel (`ch2`)

Select a scroll list with key `<4>` or `<6>`.

The list items are displayed in the lower line.

Press key `<8>` and `<2>` to scroll through the scroll list. All measuring channels and their absolute values can be used as input channels for the calculation.

The following calculation functions are available:

- `-`: $Y = ch1 - ch2$
- `+`: $Y = ch1 + ch2$
- `(+)/2`: $Y = (ch1 + ch2) / 2$
- `(+)/n`: $Y = (ch1 + ch2) / n$
- `|-|`: $Y = |ch1 - ch2|$

Press ENTER.

```
Y: is valid if
A: and B: valid
```

This message will be displayed after the parameterization of the calculation channel if the calculation function `(+)/2` is selected. The measured values of the calculation channel (here: `Y`) will be valid if the measured values of both measuring channels (here: `A` and `B`) are valid. If only one measuring channel provides valid measured values, the measured values of the calculation channel will be invalid.

```
Y: is valid if
A: or B: valid
```

This message will be displayed after the parameterization of the calculation channel if the calculation function `(+)/n` is selected. The measured values of the calculation channel (here: `Y`) will be valid if the measured values of at least one measuring channel (here `A` or `B`) are valid. If only one measuring channel provides valid measured values, these measured values will be used for the calculation channel.

13.8.3 Output Options for a Calculation Channel

```
Output Options ↓
for Channel Y:
```

Select a calculation channel in the program branch Output Options. Press ENTER.

```
Physic. Quant. ↓
Mass Flow
```

Select the physical quantity to be calculated. Press ENTER.

Make sure that the physical quantity selected for the calculation channel can be calculated from the physical quantities of the selected measuring channels. Possible combinations are shown in Tab. 13.2.

Tab. 13.2: Physical quantity of the calculation channel

physical quantity of the calculation channel	possible physical quantity of the first measuring channel (ch1)				possible physical quantity of the second measuring channel (ch2)			
	flow velocity	volumetric flow rate	mass flow rate	heat flow rate	sound speed	volumetric flow rate	mass flow rate	heat flow rate
flow velocity	x	x	x	x	x	x	x	x
volumetric flow rate		x	x	x		x	x	x
mass flow rate		x	x	x		x	x	x
heat flow rate				x				x

example 1: The difference of the volume flow rates of the channels A and B is to be calculated.

The physical quantity of channel A and B can be the volumetric flow rate or the mass flow rate, but not the flow velocity. The physical quantities of the two measuring channels do not need to be identical (channel A = mass flow rate, channel B = volumetric flow rate).

example 2: To determine the heat flow difference, the physical quantity of the two input channels has to be the heat flow.

```
Mass in: ↓
kg/h
```

Select the unit of measurement. Press ENTER.

Two cut-off flow values for each calculation channel can be defined. They are defined in the unit of measurement of the physical quantity selected for the calculation channel.

```
+Cut-off Flow
  1.00    kg/h
```

All positive calculated values that are lower than the limit will be set to 0.

```
-Cut-off Flow
 -2.00    kg/h
```

All negative calculated values that are greater than the limit will be set to 0.

```
Store Meas.Data
>NO<      yes
```

The data logger can be activated/deactivated. Press ENTER.

13.8.4 Measuring with Calculation Channels

```
par >MEA< opt sf
Measuring
```

Select the program branch *Measuring*. Press ENTER.

```
CHANN: A B >Y< Z
MEASUR ✓ ✓ ✓ .
```

Activate the necessary channels. Calculation channels are activated or deactivated in the same way as the measuring channels. Press ENTER.

```
WARNING! CHANNEL
        B: INACTIV!
```

If a measuring channel that is needed for an activated calculation channel has not been activated, a warning will be displayed. Press ENTER.

Position the transducers for all activated measuring channels. The measurement will be started automatically.

```
Y: Flow Velocity
  53.41    m/s
```

If a calculation channel is activated, the HumanMux mode (see section 12.2.2) will be selected at the beginning of the measurement and the values of the calculation channel will be displayed.

If the AutoMux mode is selected, the measured values of the measuring channels, but not the measured values of the calculation channels, will be displayed alternately.

```
Y: A - B
  53.41    m/s
```

Press key to display the calculation function.

Press key to display the measured values of the various channels.

13.9 Change of the Limit for the Inner Pipe Diameter

It is possible to change the lower limit of the inner pipe diameter for a given transducer type.

Enter HotCode **071001** immediately after the transmitter has been switched on.

```
DNmin Q-Sensor
  15      mm
```

Enter the lower limit of the inner pipe diameter of the displayed transducer type. Press ENTER to select the next transducer type.

Note!

If a transducer is used below its recommended inner pipe diameter, a measurement might be impossible.

13.10 Diagnosis by means of the Snap Function

With the aid of the snap function it is possible to store measuring parameters which are useful for the evaluation of measuring results or for diagnostic purposes.

The snap function is activated in Special Funct.\SYSTEM settings\Signal snap\DSP-SignalSnap.

```
DSP-SignalSnap
off              >ON<
```

Select `on` to activate the snap function. Select `off` to deactivate the snap function. Press ENTER.

Settings for the snap memory

```
DSP-SignalSnap
Install Snap
```

Select `Install Snap`. Press ENTER.

```
Snap-Memory
  5      NUM
```

Enter the number of the snap memory capacity. Press ENTER.

```
AutoSnap
>NO<      yes
```

Activation and deactivation of the auto-snap function. Press ENTER.

```
Snap ringbuffer
>NO<      yes
```

Activation and deactivation of the snap ringbuffer. Press ENTER.

Delete snaps

```
DSP-SignalSnap  
Clear Snaps
```

Select Clear Snaps. Press ENTER.

Read snaps

```
DSP-SignalSnap  
Snaps ->Rs232
```

Select Snaps ->Rs232. Press ENTER.

Activation of the snap function

In order to activate a snap function, press key during the measurement.

14 Data Logger and Transmission of Data

The transmitter has a data logger in which the measured values are stored during the measurement (see section 14.1).

The measured values are transmitted to a PC via the serial interface directly during the measurement (see section 14.2).

For the connection of the serial interface to the transmitter see section 6.7 (FLUXUS F601) or section 7.7 (FLUXUS F608).

14.1 Data Logger

The following data will be stored:

- date
- time
- measuring point number
- pipe parameters
- fluid parameters
- transducer data
- sound path (reflection or diagonal arrangement)
- transducer distance
- damping factor
- storage rate
- physical quantity
- unit of measurement
- measured values (physical quantity and input quantities)
- values of the totalizers (if totalizers is activated)
- diagnostic values (if storing of diagnostic values is activated)

In order to store the measured data, the data logger has to be activated (see section 14.1.1).

The available data logger memory can be displayed (see section 14.1.6).

The storing of each measured value will be signalized acoustically. This signal can be de-activated (see section 14.1.3 in Acoustic Signal).

14.1.1 Activation/Deactivation of the Data Logger

```
Output Options:
for Channel  A:
```

Select in the program branch `Output Options` the channel for which the data logger is to be activated. Press `ENTER`.

This display will not be indicated if the transmitter has only one measuring channel.

```
Store Meas.Data
no           >YES<
```

Press `ENTER` until the menu item `Store Meas.Data` is displayed.

Select `yes` to activate the data logger, `no` to deactivate it. Press `ENTER`.

14.1.2 Setting the Storage Rate

The storage rate is the frequency at which the measured values are transmitted or stored. The storage rate is set separately for each measuring channel.

If the storage rate is not set, the storage rate which was selected previously will be used.

The storage interval should be at least equal to the number of activated measuring channels, e.g., the storage interval of a channel should be min. 2 s if 2 measuring channels are activated, min. 4 s are recommended.

```
Storage Rate  ↓
Once per 10 sec.
```

Select a storage rate or EXTRA. Press ENTER.

This display will only be indicated if Store Meas.Data and/or Serial Output are activated.

```
Storage Rate
          1      s
```

If EXTRA is selected, enter the storage rate. Press ENTER.

14.1.3 Settings for the Data Logger

Select Special Funct.\SYSTEM settings\Storing. It contains the following menu items:

- ringbuffer
- storage mode
- storing of the totalizers
- storing of the signal amplitude
- storing the sound speed of the fluid
- storing of the diagnostic values
- start of Storing
- acoustic signal during the storing

Ringbuffer

Setting the ringbuffer influences the storing of measured values once the data logger is full.

- If the ringbuffer is activated, the available data logger will be halved. The oldest measured values will be overwritten. Only the data logger memory that was free during the activation will be used by the ringbuffer. If more data logger memory is necessary, measured values in the data logger should previously be deleted.
- If the ringbuffer is deactivated, the storing of measured values will be stopped.

```
Ringbuffer
off          >ON<
```

Select the behavior of the ringbuffer. Press ENTER.

Storage mode

```
Storage mode
>SAMPLE< average
```

Select the storage mode. Press ENTER.

If `sample` is selected, the displayed measured value will be used for storing and online transmission of data.

If `average` is selected, the average of all values measured during a storage interval will be used for storing and online transmission of data.

Note! The storage mode does not affect the outputs.

Note!

Storage mode = average

The average of the physical quantity and other physical quantities assigned to the measuring channel, e.g., the measured temperature, will be calculated.

If the storage rate < 5 s (see section 14.1.2) is selected, the `sample` will be used.

If no average could be calculated over the complete storage interval, the value will be marked as invalid. The ASCII file will contain `???` for invalid average values of the measured values and `?UNDEF` instead of invalid temperatures.

Storing of the totalizers

See section 13.2.

Storing of the signal amplitude

```
Store Amplitude
off >ON<
```

If `on` is selected and the data logger is activated, the amplitude of the measured signal will be stored together with the measured values. Press ENTER.

Storing of the sound speed of the fluid

```
Store c-Medium
off >ON<
```

If `on` is selected and the data logger is activated, the sound speed of the fluid will be stored together with the measured values. Press ENTER.

Storing of the diagnostic values

```
Store diagnostic
off >ON<
```

If `on` is selected and the data logger is activated, the diagnostic values will be stored together with the measured values. Press ENTER.

Start of storing

In order to start storing of measured values with several measuring instruments at the same time it is possible to set a starting time.

```
Start logger  ↑
Promptly
```

Select the moment at which the storing has to start.

Promptly: The storing starts immediately.

On full 5 min.: The storing starts in the next full 5 minutes.

On full 10 min.: The storing starts in the next full 10 minutes.

On quarter hour: The storing starts in the next full 15 minutes.

On half hour: The storing starts in the next 30 minutes.

On full hour: The storing starts in the next full hour.

example: actual time: 09:06 am
 setting: On full 10 min.
 The storing starts at 09:10 am.

Acoustic signal during the storing

Per default, an acoustic signal will be emitted every time a measured value is stored or transmitted to a PC or printer. The signal can be deactivated in Special Funct.\SYSTEM settings\Storing\Beep on storage.

```
Beep on storage
>on<            off
```

Select `off` to deactivate the acoustic signal, `on` to activate it. Press ENTER.

14.1.4 Measurement with Activated Data Logger

- Start the measurement.

```
A:Meas.Point No.:
   xxx (↑↓← →)
```

Enter the measuring point number. Press ENTER.

If arrows are displayed in the lower line on the right, ASCII text can be entered. If digits are displayed, only digits, point and hyphen can be entered.

For the setting of the input mode see section 17.2.3.

If Output Options\Store Meas.Data has been activated and Special Funct.\SYSTEM settings\Ringbuffer is deactivated, this error message will be displayed as soon as the data logger is full.

```
DATA MEMORY
OVERFLOW!
```

Press ENTER.

The error message will be displayed periodically.

If no other output (transmission of data, outputs) has been activated, the measurement will be stopped.

If another output has been activated, the measurement will be continued. Only the storing of the measured values will be stopped.

14.1.5 Deleting the Measured Values

```
Special Funct. ↓
Delete Meas.Val.
```

Select Special Funct.\Delete Meas.Val.. Press ENTER.

```
Really Delete?
no             >YES<
```

Select yes or no. Press ENTER.

14.1.6 Available Data Logger Memory

If the data logger is empty and a measurement is started with one physical quantity on one measuring channel without storing the totalizer, approx. 100 000 measured values can be stored. The available data logger memory can be displayed:

```
Special Funct. ↓
Instrum. Inform.
```

Select Special Funct.\Instrum. Inform.. Press ENTER.

```
F60X-XXXXXXXX
Free          18327
```

The type and the serial number of the transmitter is displayed in the upper line.

The available data logger memory will be displayed in the lower line (here: 18 327 additional measured values can be stored). Press key BRK twice to return to the main menu.

Max. 100 series of measured values can be stored. The number of series of measured values depends on the total number of measured values stored in the previous series of measured values.

The time at which the data logger will be full, will be displayed during the measurement. All activated channels, totalizers and other values will be considered.

```
full= 26.01/07:39
      54.5      m3/h
```

Press key to scroll through the display of the upper line.

```
last= 26.01/07:39
      54.5      m3/h
```

If the ringbuffer is activated and has overflowed at least once, this display will be indicated.

14.2 Transmission of Data

The measured values are transmitted via a serial interface RS232 to a PC.

14.2.1 Online Transmission of Data

The measured values are transmitted during the measurement. If the data logger is activated, the measured values will also be stored.

Tab. 14.1: Overview online transmission of data

serial interface	transmission of data	see
RS232	terminal program	section 14.2.5

14.2.2 Offline Transmission of Data

The measurement data of the data logger are transmitted.

Tab. 14.2: Overview offline transmission of data

serial interface	transmission of data	see
RS232	terminal program	section 14.2.6
RS232	FluxData	section 14.2.7

14.2.3 Formatting of the Measurement Data

Select Special Funct.\SYSTEM settings\serial transmis.

```
SER:kill spaces
off >ON<
```

Select on if the space characters are not to be transmitted. Press ENTER.

The file size will be considerably smaller (shorter transmission time).

```
SER:decimalpoint
'.' >','<
```

Select the decimal marker to be used for floating-point numbers (point or comma). Press ENTER.

This setting depends on the setting of the operating system of the PC.

```
SER:col-separat.
';'      >'TAB'<
```

Select the character to be used to separate columns (semicolon or tabulator). Press ENTER.

14.2.4 Transmission Parameters

- the transmitter sends CRLF-terminated ASCII
- max. line length: 255 digits

RS232

- default: 9600 bits/s, 8 data bits, even parity, 2 stop bits, protocol RTS/CTS (hardware, handshake)

The transmission parameters of the RS232 interface can be changed:

Enter HotCode **232-0**- immediately after the transmitter has been switched on.

```
BAUD<data par st
9600 8bit EVEN 2
```

Set the transmission parameters in the 4 scroll lists. Press ENTER.

- baud: baud rate
- data: number of data bits
- par: parity
- st: number of stop bits

14.2.5 Online Transmission of Data to a Terminal Program

- Start the terminal program.
- Enter the transmission parameters into the terminal program (see section 14.2.4). The transmission parameters of the terminal program and of the transmitter have to be identical.
- Select the program branch `Output Options`. Press ENTER.
- Select the channel for which the online transmission of data is to be activated. Press ENTER until the menu item `Serial Output` is displayed.

```
Serial Output
no      >YES<
```

Select `yes` to activate the online transmission of data. Press ENTER.

- Set the storage rate (see section 14.1.2).
- Start the measurement. The measuring point number will be requested (see section 14.1.4).

```
SEND ONLINE-HEAD
20      mm
```

The measured values are transmitted during the measurement.

14.2.6 Offline Transmission of Data to a Terminal Program

- Start the terminal program.
- Enter the transmission parameters into the terminal program (see section 14.2.4). The transmission parameters of the terminal program and of the transmitter have to be identical.

```
Special Funct. ↓
Print Meas.Val.
```

Select Special Funct.\Print Meas.Val.. Press ENTER.

```
NO VALUES      !
Print Meas.Val.
```

This error message will be displayed if no measured values are stored. Press ENTER.

```
Send Header    01
.....
```

This message will be displayed if the measuring signal is sufficient.

```
■■■■■■■
.....
```

The progress of the transmission of data is displayed by a bar graph.

```
SERIAL ERROR   !
Print Meas.Val.
```

This error message will be displayed if an error has occurred during the serial transmission. Press ENTER. Check the connections and make sure that the PC is ready to receive data.

14.2.7 Offline Transmission of Data with the Program FluxData

The measurement data in the data logger are transmitted to a PC via the serial interface RS232 with the FLEXIM program FluxData.

Settings in the transmitter

```
par mea opt >SF<
Special Funct.
```

Press BRK to select the main menu.

Further settings in the transmitter are not necessary.

Settings in the program

Start the program FluxData V3.0 or higher on the PC.

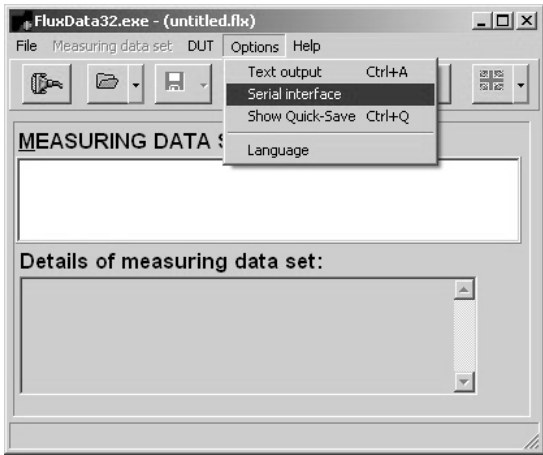
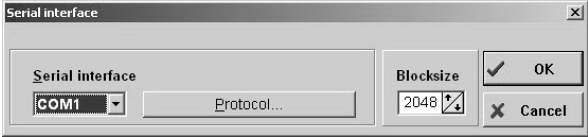
	<p>Select the menu: Options > Serial interface.</p>
	<p>Select the serial interface used from the PC (e.g., COM1). Click Protocol. Click OK.</p>

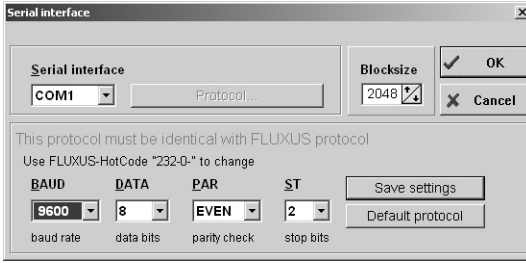

Enter the transmission parameters (see section 14.2.4). If the default settings of the transmission parameters are used, click Default protocol.

The transmission parameters of the program FluxData and of the transmitter have to be identical.

Click OK.

Transmission of data

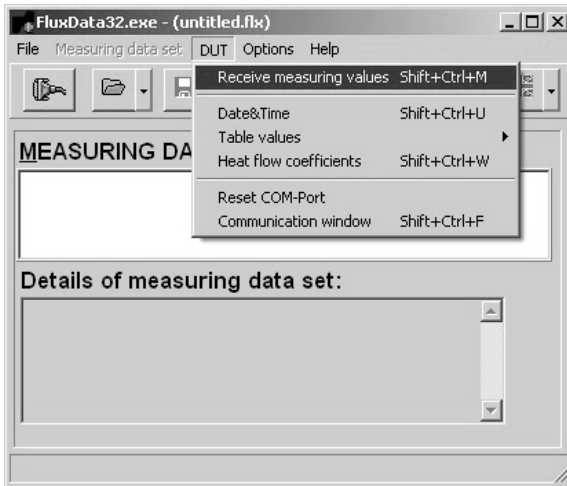

Select the menu: DUT > Receive measuring values.

Wait until the data are transmitted.

Stop of the transmission of data

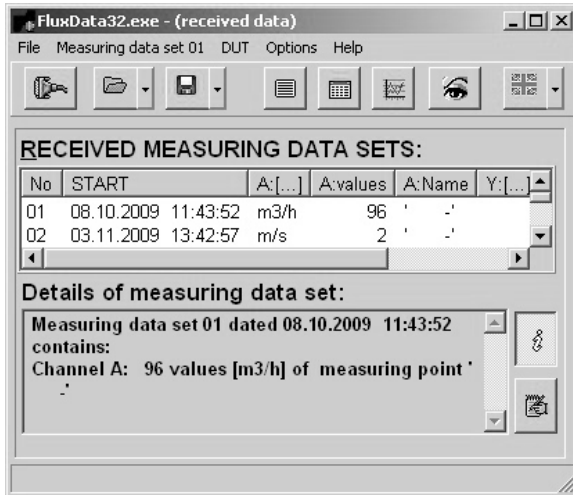

Select the menu:
File > Save.

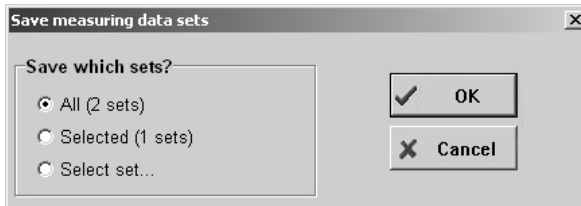

Select the series of measured values to be stored. Click OK.

Select the path on which the data should be stored and enter the file name. Click Save.

The file will be stored with the file extension .flx.

14.2.8 Structure of the Data

The header is transmitted at the beginning of the measurement. The first 4 lines contain general information about the transmitter and the measurement. The following lines contain the parameters of each channel.

```

example:      \DEVICE: F60X-XXXXXXXX
                  \MODE : ONLINE
                  DATE: 2011-01-09
                  TIME: 19:56:52
                  Par.Record
                  Meas.Point No.:: A:F5050
                  Pipe
                    Outer Diameter: 60.3 mm
                    Wall Thickness: 5.5 mm
                    Roughness: 0.1 mm
                    Pipe Material: Carbon Steel
                    Lining: WITHOUT LINING
                  Medium: Water
                    Medium Temperat.: 38 C
                  Fluid pressure: 1.00 bar
                  Transducer Type: xxx
                  Sound Path: 3 NUM
                  Transd. Distance: -15.6 mm

                  Damping: 20 s
                  Full-Scale Val.: 4.50 m3/h
                  Physic. Quant.: Volume flow
                  Unit Of Measure: [m3/h]/[m3]
                  Numb.Of Meas.Val: 100
  
```

The line \DATA is transmitted next followed once by the column titles (see Tab. 14.3) for the corresponding channel. The measured values are transmitted afterwards.

```

example:      \DATA
                  A:  \*MEASURE;Q_POS;Q_NEG;
                  B:  \*MEASURE;Q_POS;Q_NEG;
  
```

In every storage interval, one data line per activated measuring channel is transmitted. The line "???" will be transmitted if there are no measured values available for the storage interval.

example: With a storage interval of 1 s, 10 lines with "???" will be transmitted if the measurement has been restarted after a 10 s interruption for the positioning of the transducers.

The following data columns can be transmitted:

Tab. 14.3: Columns of data

column title	column format	content
*MEASURE	###000000.00	the physical quantity selected in Output Options
Q_POS	+00000000.00	totalizer value for the positive flow direction
Q_NEG	-00000000.00	totalizer value for the negative flow direction
FQ_POS		value of the totalizer for the positive flow direction (if the heat flow is selected as the physical quantity)
FQ_NEG		the value of the totalizer for the negative flow direction (if the heat flow is selected as the physical quantity)
T1	###000.0	temperature T1 (= supply temperature if the heat flow has been selected as the physical quantity)
T2	###000.0	temperature T2 (= return temperature if the heat flow has been selected as the physical quantity)
...		designation for other inputs
SSPEED		Sound speed of the fluid
AMP		signal amplitude

Online transmission of data

Columns will be created for all quantities that appear during the measurement. The columns Q_POS and Q_NEG will remain empty if the totalizers are deactivated.

As the totalizers cannot be activated for the physical quantity flow velocity, these columns will not be generated.

Offline transmission of data

During the offline transmission of data, columns will only be created if at least one measured value is stored in the data set. The columns Q_POS and Q_NEG will not be created if the totalizers are deactivated.

15 Working with Parameter Records

15.1 Introduction

Parameter records are data sets that contain all information necessary to perform a certain measurement task:

- pipe parameters
- transducer parameters
- fluid parameters
- output options

Working with parameter records will make repeated measurement tasks easier and faster. The transmitter can store max. 14 parameter records.

Note! No parameter records are stored in the delivery state. Parameter records are entered manually.

15.2 Storing of a Parameter Record

The parameters have first to be entered in the program branch `Parameter`. Afterwards, they can be stored as a parameter record.

```
Special Funct. ↓
Store Curr.Rec.
```

Select `Special Funct.\Store Curr.Rec.` Press `ENTER`.

```
NO DATA!
Store Curr.Rec.
```

This error message will be displayed if no complete parameter record is available. Storing is impossible. Enter the missing parameters in the program branch `Parameter`.

```
Store Par. To: ↓
Par.Record    01
```

14 parameter records (`Par.Record 01...Par.Record 14`) can be stored. Select a parameter record. Press `ENTER`.

```
Overwrite
no          >YES<
```

If parameters are already stored in the selected parameter record, they can be overwritten.

Select `yes` to overwrite the parameters, or `no` to select another parameter record. Press `ENTER`.

15.3 Loading of a Parameter Record

Stored parameter records can be loaded and used for measurement.

```
>PAR<mea opt sf
Parameter
```

Select the program branch `Parameter`. Press `ENTER`.

```
Parameter      ↓
for Channel    A:
```

Select the channel for which a parameter record is to be loaded. Press ENTER.

```
Parameter from: ↓
Par.Record      01
```

Select the parameter record to be loaded. Press ENTER.

```
Edit Parameters
>NO<           yes
```

Select *yes* to edit the parameters of a parameter record. Select *no* to return to the main menu and start the measurement.

Press ENTER.

15.4 Deleting Parameter Records

```
Special Funct. ↓
Delete Para.Rec.
```

Select *Special Funct.\Delete Para.Rec.*. Press ENTER.

```
NO PAR. STORED!!
Delete Para.Rec.
```

This error message will be displayed if no parameter records are stored. Press ENTER.

```
Delete:        ↓
Par.Record     01
```

This display will be indicated if parameters are stored. Select the parameter record to be deleted. Press ENTER.

```
Really Delete?
no             >YES<
```

Confirm whether to delete the parameter record. Press ENTER.

16 Libraries

The internal material database of the transmitter contains parameters for pipe and lining materials as well as for fluids. It can be extended with user defined materials or fluids. User defined materials and fluids will always be displayed in the scroll lists of the program branch `Parameter`.

User defined materials and fluids can be stored in an integrated coefficient memory (user area). The coefficient memory has to be partitioned first (see section 16.1).

The parameters of user defined materials or fluids can be entered as follows:

- as constants without the extended library (see section 16.2)
- as constants or temperature and pressure dependent functions by means of the extended library (see section 16.3)

The material and fluid scroll lists displayed in the program branch `Parameter` can be arranged (see section 16.5). Shorter scroll lists make working more efficient.

16.1 Partitioning of the Coefficient Memory

The coefficient memory can be divided into parts for the following material data:

- material parameters:
 - transversal and longitudinal sound speed
 - typical roughness
- fluid parameters:
 - min. and max. sound speed
 - kinematic viscosity
 - density
- heat flow coefficients (additional fluid parameter)
- steam coefficients (additional fluid parameter)

For the max. number of data sets for each category of these material data see Tab. 16.1.

Tab. 16.1: Capacity of the coefficient memory

	max. number of data sets	occupancy of the coefficient memory in %
materials	13	97
fluids	13	97
heat flow coefficients	29	98
steam coefficients	19	95

```
Libraries      ↑
Format USER-AREA
```

Select Special Function\SYSTEM settings\Libraries\Format USER-AREA. Press ENTER.

```
MAXIMAL:      13!
Materials:     15
```

This error message will be displayed if the entered number of data sets for a category of material data exceeds the capacity of the coefficient memory.

```
Format USER-AREA
Materials:     03
```

Enter the number of the user defined materials. Press ENTER.

```
Format USER-AREA
Media:        03
```

Enter the number of the user defined fluids. Press ENTER.

```
Format USER-AREA
Heat-Coeffs:  00
```

Enter the number of user defined data sets for the heat flow coefficients. Press ENTER.

Heat flow coefficients can only be entered if the transmitter has temperature inputs.

```
Format USER-AREA
Steam-Coeffs: 00
```

Enter the number of user defined data sets for the steam coefficients. Press ENTER.

Steam coefficients can only be entered if the transmitter has temperature inputs.

```
USER AREA:
  52%   used
```

The occupancy of the coefficient memory is displayed for a few seconds.

```
Format NOW?
no          >YES<
```

Select *yes* to start the partitioning. Press ENTER.

```
FORMATTING ...
■■■■■■■ ...
```

The coefficient memory is being partitioned. This procedure takes a few seconds.

```
Libraries      ↑
Format USER-AREA
```

After the partitioning, *Format USER-AREA* is displayed again.

16.1.1 Keeping Data during Formatting of the Coefficient Memory

When the coefficient memory is repartitioned, max. 8 data sets of each type can be retained.

example 1: The number of user defined materials is reduced from 5 to 3. The data sets #01 to #03 are retained. The data sets #04 and #05 are deleted.

example 2: The number of user defined materials is increased from 5 to 6. All 5 data sets are kept.

16.2 Input of Material/Fluid Parameters without the Extended Library

To enter the material/fluid parameters as constants, the extended library has to be deactivated.

```
Libraries      ↓
Extended Library
```

Select Special Function\SYSTEM settings\Libraries\Extended Library. Press ENTER.

```
Extended Library
>OFF<          on
```

Select off to deactivate the extended library. Press ENTER.

The parameter of a user defined material/fluid can be entered now.

The input of a material or a fluid is almost identical. Therefore, the displays for a fluid will only be shown and described in case of differences.

```
Special Funct. ↓
Install Material
```

Select Special Function\SYSTEM settings\Install Material or Install Medium

```
USER Material
NOT FORMATTED !
```

An error message will be displayed if the coefficient memory does not contain an area for user defined materials/fluids.

Partition the coefficient memory accordingly (see section 16.1).

```
Install.Material
>EDIT<    löschen
```

Select edit. Press ENTER.

```
USER Material ↓
#01:--not used--
```

Select a user defined material/fluid. Press ENTER.

```
EDIT TEXT (↑↓← →)
USER Material 1
```

Change the designation of the material/fluid.

The default name for a user defined material/fluid is `USER MATERIAL N` or `USER MEDIUM N` with `N` being an integer.

Note!

95 ASCII characters (letters, capital letters, numbers, special characters [! ? " + - () > < % * etc.]) are available for the designation of materials/fluids.

A designation can have max. 16 characters. The input of text is described in section 4.3.

Material parameter

```
c-Material
  1590.0   m/s
```

Enter the sound speed of the material. Press ENTER.

For the sound speed of some materials see annex C.1.

```
Roughness
  0.4     mm
```

Enter the roughness of the material. Press ENTER.

For the typical roughness of some materials see annex C.2.

Fluid parameter

```
c-Medium
  1500.0   m/s
```

Enter the average sound speed of the fluid. Press ENTER.

```
c-Medium range
  auto     >USER<
```

Select `auto` or `user`. Press ENTER.

`auto`: : The area around the average sound speed is defined by the transmitter.

`user`: The area around the average sound speed has to be entered.

```
c-Medium=1500m/s
range +/-150m/s
```

Enter the range around the average sound speed of the fluid. Press ENTER.

This display will only be indicated if `user` is selected.

```
Kinem.Viscosity
  1.01    mm2/s
```

Enter the kinematic viscosity of the fluid. Press ENTER.

```
Density
  1.00    g/cm3
```

Enter the density of the fluid. Press ENTER.

16.3 Extended Library

16.3.1 Introduction

If the extended library is activated, it is possible to enter material and fluid properties as a function of the temperature or of the pressure and additional fluid parameters (heat flow coefficients, steam coefficients and concentration coefficients) directly into the transmitter or by means of the program FluxKoef.

Tab. 16.2: Material and fluid parameters that can be stored

parameter	parameters necessary for...
material parameter	
transversal sound speed	flow measurement
longitudinal sound speed	flow measurement, wall thickness measurement
type of sound wave	flow measurement
typical roughness	profile correction of the flow velocity
fluid parameter	
sound speed	start of the measurement
viscosity	profile correction of the flow velocity
density	mass flow rate calculation
additional fluid parameters	
heat flow coefficients	heat flow measurement
steam coefficients	heat flow measurement with steam in supply line

Enter only the properties needed for the measuring task.

example: The density of a fluid is unknown. If the mass flow rate is not measured, any constant value can be entered as the density.
The measurement of the flow velocity and the volumetric flow rate will not be affected. However, the value of the mass flow rate will be wrong.

The dependence of the material/fluid parameters on the temperature and pressure can be described

- as constants
- as linear function
- with polynomials of grade 1 to 4
- with customized interpolation functions

In most cases, constants or a linear function are sufficient.

If, e.g., the temperature fluctuations at the measuring point are low compared to the temperature dependence of the material properties, the linearization or the complete neglect of the temperature dependency will not result in a considerable additional measuring error.

If, however, the process conditions fluctuate strongly and the fluid parameters depend strongly on the temperature (e.g., viscosity of hydraulic oil), polynomials or customized interpolation functions should be used. Contact FLEXIM to find the best solution for the measuring task.

Customized interpolation functions

Some dependencies are only approximated insufficiently by polynomials. A number of customized interpolation functions `Basics: Y=F(X,Z)` are available to interpolate multidimensional dependencies $y = f(T, p)$. For further information contact FLEXIM.

16.3.2 Activation of the Extended Library

```
Extended Library
off                >ON<
```

Select `Special Function\SYSTEM settings\Libraries\Extended Library`. Press ENTER.

Select `on` to activate the extended library. Press ENTER.

16.3.3 Input of the Material/Fluid Parameters

The parameter of a user defined material/fluid can be entered now.

The input of a material or a fluid is almost identical. Therefore, the displays for a fluid will only be shown and described in case of differences.

```
Special Funct. ↑
Install Material
```

Select `Special Function \Install Material or Install Medium`. Press ENTER.

```
USER Material
NOT FORMATTED !
```

An error message will be displayed if the coefficient memory does not contain an area for user defined materials/fluids.

Partition the coefficient memory accordingly (see section 16.1).

```
Edit Material ↓
Basics:Y=m*X +n
```

Select the function for the temperature or pressure dependence of the material/fluid parameter:

Y=CONST.: constants

Y=M*X+N: linear function of the temperature

Y=Polynom: $y = k_0 + k_1 \cdot x + k_2 \cdot x^2 + k_3 \cdot x^3 + k_4 \cdot x^4$

Y=F(X, Z) : customized interpolation function (only for experienced users or after consultation with FLEXIM)

go back: return to the previous menu item

```
USER Material ↓
#01:--not used--
```

Select a user defined material/fluid.

```
USER Material 2
>EDIT<      delete
```

Select edit to edit the material/fluid parameters or delete to delete the material/fluid and to return to the scroll list Edit Material or Edit Medium.

This display will only be indicated if an already existing material/fluid has been selected.

```
#2: Input Name:
USER Material 2
```

Enter the designation of the material/fluid. Press ENTER.

The default name for a user defined material/fluid is USER MATERIAL N or USER MEDIUM N with N being an integer.

Material parameter

Enter the material's:

- transversal sound speed
- longitudinal sound speed

1...5 values depending on the selected function have to be entered. Press ENTER after each input.

If an already defined material is edited, for each parameter there will be a request whether it is to be edited. Select yes or no. Press ENTER. Change the values, if necessary.

```
Default soundsp.
long.      >TRANS.<
```

Select the type of sound wave to be used for the flow measurement. Press ENTER.

For most materials, a transversal sound wave has to be selected.

```
Roughness
0.4      mm
```

Enter the typical roughness of the material. Press ENTER.

```
Save changes
no      >YES<
```

Select yes to store the entered parameters or no to quit the menu item without storing. Press ENTER.

Fluid parameter

Enter the fluid's:

- longitudinal sound speed
- kinematic viscosity
- density

Depending on the selected function, 1...5 values have to be entered. Press ENTER after each input.

If an already defined fluid is edited, for each parameter of some of the functions there will be a request whether it is to be edited. Select `yes` or `no`. Press ENTER. Change the values, if necessary.

```
Save changes
no          >YES<
```

Select `yes` to store the entered properties, `no` to quit the menu item without storing. Press ENTER.

16.3.4 Input of Heat Flow Coefficients

Note! The heat flow coefficients can also be edited with the programs FluxData and FluxKoeff.

Note! The entered coefficients will not be checked. Absurd values can result in wrong measured values or in permanent system errors.

Select Special Function\Install. Medium. Press ENTER.

```
Edit Medium   ↓
Heat-flow coeffs
```

Select Heat-flow coeffs. Press ENTER.

```
Heat-flow coeffs
NOT FORMATTED !
```

This error message will be displayed if the coefficient memory does not contain an area for the heat flow coefficients.

Partition the coefficient memory accordingly (see section 16.1).

```
Heat-Coeffs for ↓
Beer
```

Select the fluid for which the heat flow coefficients have to be entered.

User defined fluids will be displayed first, followed by the fluids of the internal database.

```
Select index   ↓
02(--not used--)
```

Select an index for storing the heat flow coefficients of the selected fluid. Press ENTER.

If the coefficient memory is partitioned in such way that heat flow coefficients for two fluids can be entered, indices 01 and 02 are available.

```
Heat-flow coeffs
      0.0 a0
```

Enter the 10 heat flow coefficients: a0...a4, r0...r4. Press ENTER after each input.

```
Heat-flow coeffs
Save? no >YES<
```

Select *yes* to store the heat flow coefficients. Press ENTER.

16.3.5 Input of the Steam Coefficients

Use the program FluxKoef (optional).

Note!	The entered coefficients will not be checked. Absurd values can result in wrong measured values or cause permanent system errors.
--------------	---

16.4 Deleting a User Defined Material/Fluids

To delete a user defined material/fluid, proceed as follows:

Select `Special Function\Install.Material` or `Install. Medium`. Press ENTER.

If the extended library is activated, press ENTER until the request for deleting is displayed.

```
Install.Material
edit >DELETE<
```

Select *delete*. Press ENTER.

```
USER Material
#01: Polystyrene
```

Select the material/fluid to be deleted. Press ENTER.

```
Really Delete?
no >YES<
```

Select *yes* or *no*. Press ENTER.

16.5 Arrangement of the Material/Fluid Scroll List

The materials and fluids to be displayed in the program branch `Parameter` are arranged in the material scroll list or in the fluid scroll list.

Note! User defined materials/fluids will always be displayed in the scroll lists of the program branch `Parameter`.

```
SYSTEM settings ↓
Libraries
```

Select `Special Function\SYSTEM settings\Libraries`.

Press ENTER.

```
Libraries ↓
Material list
```

Select `Material list` to edit the material scroll list or `Medium list` to edit the fluid scroll list.

Select back to return to `SYSTEM` setting. Press ENTER.

```
Material list
factory >USER<
```

Select `factory` if all materials/fluids of the internal database are to be displayed in the scroll list. An already existing scroll list will not be deleted but only deactivated.

Select `user` to activate the user defined scroll list. Press ENTER.

```
Material list ↓
>Show list
```

If `user` is selected, the material or fluid scroll list can be edited (see section 16.5.1 to 16.5.3).

```
Material list ↓
>End of Edit
```

Select `End of Edit` to stop editing. Press ENTER.

```
Save List ?
no >YES<
```

Select `yes` to store all changes of the scroll list or `no` to quit the menu item without storing. Press ENTER.

Note! If the material/fluid scroll list is quit by pressing key `BRK` before storing, all changes will be lost.

16.5.1 Displaying a Scroll List

```
Material list ↓
>Show list
```

Select `Show list`. Press ENTER to display the scroll list as in the program branch `Parameter`.

```
Current list= ↓
Other Material
```

The current scroll list is displayed in the lower line.

Press ENTER to return to the scroll list `Material list` or `Medium list`.

16.5.2 Adding a Material/Fluid to the Scroll List

```
Material list  ↑
>Add Material
```

Select `Add Material` or `Add Medium` to add a material/fluid to the scroll list. Press ENTER.

```
>Add Material  ↑
Stainless Steel
```

All materials/fluid that are not contained in the current scroll list will be displayed in the lower line.

Select the material/fluid. Press ENTER. The material/fluid will be added to the scroll list.

Note! The materials/fluids are displayed in the order in which they have been added.

16.5.3 Adding all Materials/Fluids to the Scroll List

```
Material list  ↑
>Add all
```

Select `Add all` to add all materials/fluids of the database to the current scroll list. Press ENTER.

16.5.4 Removing a Material/Fluid from the Scroll List

```
Material list  ↑
>Remove Material
```

Select `Remove Material` or `Remove Medium` to remove a material/fluid from the scroll list. Press ENTER.

```
>Remove Material ↑
Stainless Steel
```

All materials/fluids of the current scroll list will be displayed in the lower line.

Select the material/fluid. Press ENTER. The material/fluid will be removed from the scroll list.

Note! User defined materials/fluids will always be displayed in the scroll lists of the program branch `Parameter`. They cannot be removed.

16.5.5 Removing all Materials/Fluids from the Scroll List

```
Material list  ↑
>Remove all
```

Select `Remove all` to remove all materials/fluids from the scroll list. Press ENTER. User defined materials/fluids will not be removed.

17 Settings

17.1 Time and Date

The transmitter has a battery-powered clock. Measured values are automatically stored with the date and time.

17.1.1 Time

```
SYSTEM settings↓
Set Clock
```

Select Special Funct.\SYSTEM settings\Set Clock. Press ENTER.

```
TIME          11:00
ok            >NEW<
```

The current time is displayed. Select `ok` to confirm the time or `new` to set the time. Press ENTER.

```
TIME          11:00
Set Time      !
```

Select the character to be edit with key `<4>` and `<6>`.

Edit the selected character with key `<8>` and `<2>`. Press ENTER.

```
TIME          11:11
>OK<         new
```

The new time is displayed. Select `ok` to confirm the time or `new` to set the time again. Press ENTER.

17.1.2 Date

After the time has been set, DATE is displayed.

```
DATE 2011-01-25
ok            >NEW<
```

Select `ok` to confirm the date or `new` to set the date. Press ENTER.

```
DATE 2011-01-25
Set Date     !
```

Select the character to be edit with key `<4>` and `<6>`.

Edit the selected character with key `<8>` and `<2>`. Press ENTER.

```
DATE 2011-01-26
>OK<         new
```

The new date is displayed. Select `ok` to confirm the date or `new` to set the date again. Press ENTER.

17.2 Dialogs and Menus

```
SYSTEM settings↓
Dialogs/Menu
```

Select Special Funct.\SYSTEM settings\Dialogs/Menu. Press ENTER.

Note!

The settings will be stored at the end of the dialog. If the menu item is quit by pressing key BRK, the changes will not be stored.

17.2.1 Pipe Circumference

```
Pipe Circumfer.
off                >ON<
```

Select `on` if the pipe circumference is to be entered instead of the pipe diameter in the program branch `Parameter`. Press `ENTER`.

```
Outer Diameter
100.0           mm
```

If `on` is selected for `Pipe Circumfer.`, the outer pipe diameter will nevertheless be requested in the program branch `Parameter`.

To select the menu item `Pipe Circumfer.`, enter `0` (zero). Press `ENTER`.

```
Pipe Circumfer.
314.2           mm
```

The value displayed in `Pipe Circumfer.` is calculated on the basis of the last displayed value of the outer pipe diameter.

example: $100 \text{ mm} \cdot \pi = 314.2 \text{ mm}$

```
Pipe Circumfer.
180             mm
```

Enter the pipe circumference. The limits for the pipe circumference are calculated on the basis of the limits for the outer pipe diameter.

```
Outer Diameter
57.3            mm
```

During the next scroll through the program branch `Parameter`, the outer pipe diameter that corresponds to the entered pipe circumference will be displayed.

example: $180 \text{ mm} : \pi = 57.3 \text{ mm}$

Note!

The pipe circumference is only edited temporarily. When the transmitter switches back to the display of the pipe circumference (internal recalculation), slight rounding errors may occur.

example:

entered pipe circumference: 100 mm
displayed outer pipe diameter: 31.8 mm

When the transmitter switches back to the display of the pipe circumference, 99.9 mm will be displayed.

17.2.2 Fluid Pressure

The dependence of the parameters of a fluid on the pressure can be taken into account.

```
Fluid pressure
off                >ON<
```

If `on` is selected, the fluid pressure will be requested in the program branch `Parameter`.

If `off` is selected, 1 bar will be used for all calculations.

Note!

For documentation purposes, it is useful to enter the fluid pressure, even if the transmitter contains no pressure-dependent characteristic curves.

17.2.3 Measuring Point Number

```
Meas.Point No.:
(1234) >(↑↓← →)<
```

Select (1234) if the measuring point is to be identified only by numbers, point and dash.

Select (↑↓← →) if the measuring point is to be designated with ASCII characters.

17.2.4 Sound Path

```
Sound Path
auto >USER<
```

recommended setting: `user`

- `user`: In the program branch `Measuring`, a value for the number of sound paths is recommended. This value can be changed.
- `auto`: In the program branch `Measuring` it is possible to select between reflection arrangement and diagonal arrangement.

17.2.5 Transducer Distance

```
Transd. Distance
auto >USER<
```

recommended setting: `user`

- `user` will be selected if the measuring point is always the same.
- `auto` can be selected if the measuring point changes often.

```
Transd. Distance?
(50.8) 50.0 mm
```

In the program branch `Measuring`, the recommended transducer distance will be displayed in parentheses, followed by the entered transducer distance if the recommended and the entered transducer distance are not identical.

```
Transd. Distance?
50.8 mm
```

During transducer positioning in the program branch `Measuring`

- only the entered transducer distance will be displayed if `Transd. Distance = user` is selected and the recommended and the entered transducer distances are identical
- only the recommended transducer distance will be displayed if `Transd. Distance = auto` is selected.

17.2.6 Steam in the Supply Line

```
Steam in inlet
off           >ON<
```

Select `on` if the fluid in the supply line can be vaporous during the heat flow measurement (see section 20.6). In this case, the supply pressure will have to be entered in the program branch `Parameter`.

17.2.7 Temperature Correction

```
Tx Corr.Offset
off           >ON<
```

Select `on` to enable the input of a temperature correction for each temperature input (see section 21.5).

17.2.8 Error Value Delay

The error value delay is the time after which an error value will be sent to an output if no valid measured values are available.

```
Error-val. delay
damping      >EDIT<
```

Select `edit` to enter an error value delay. Select `damping` if the damping factor is to be used as the error value delay.

For further information on the behavior of missing measured values see section 22.1.2 and 22.2.

17.2.9 Alarm State Indication

```
SHOW RELAIS STAT
off           >ON<
```

Select `on` to display the alarm state during the measurement.

For further information on the alarm outputs see section 22.7.

17.2.10 Units of Measurement

It is possible to set the units of measurement for the length, temperature, pressure, density and kinematic viscosity and sound speed:

```
Length unit
>[mm]<      [inch]
```

Select `mm` or `inch` as the unit of measurement for the length. Press `ENTER`.

```
Temperature
>[°C]<      [°F]
```

Select `°C` or `°F` as the unit of measurement for the temperature. Press `ENTER`.

```
Pressure
>[bar]<      [psi]
```

Select `bar` or `psi` as the unit of measurement for the pressure. Press `ENTER`.

```
Density [lb/ft3]
no      >YES<
```

Select `yes` if lb/ft^3 is to be used as the unit of measurement for the density. Press ENTER.

```
Density unit
g/cm3   >kg/m3<
```

Select g/cm^3 or kg/m^3 as the unit of measurement for the density. Press ENTER.

This display will only be indicated if lb/ft^3 has not been selected as the unit of measurement for the density.

```
Viscosity unit
mm2/s   >cSt<
```

Select mm^2/s or cSt as the unit of measurement for the kinematic viscosity. Press ENTER.

```
Soundspeed unit
>[m/s]<  [fps]
```

Select m/s or fps as the unit of measurement for the sound speed. Press ENTER.

17.2.11 Setting for the Fluid Pressure

It is possible to set whether the absolute or the relative pressure will be used:

```
Pressure absolut
off     >ON<
```

Select `on` or `off`. Press ENTER.

If `on` is selected, the absolute pressure p_a will be displayed/input/transmitted.

If `off` is selected, the relative pressure p_g will be displayed/input/transmitted.

$$p_g = p_a - 1.01 \text{ bar}$$

```
Fluid pressure
1.00 bar(a)
```

The pressure and its unit of measurement will, e.g., be displayed in the program branch `Parameter`. It will be followed by the selected pressure, indicated in parentheses.

a - absolute pressure

g - relative pressure

Note! The settings will be stored at the end of the dialog.

17.3 Measurement Settings

```
SYSTEM settings↓
Measuring
```

Select `Special Funct.\SYSTEM settings\Measuring`. Press ENTER.

Note! The settings will be stored at the end of the dialog. If the menu item is quit by pressing key BRK, the changes will not be stored.

```
WaveInjector
off >ON<
```

This menu item will only be displayed if a WaveInjector is in the scope of supply (see user manual of the WaveInjector).

```
Compare c-fluid
no >YES<
```

Select `yes` if the measured sound speed is to be compared to the theoretical or expected value. The difference

$$\delta c = c_{\text{mea}} - c_{\text{stored}}$$

between the two sound speeds will be displayed during the measurement. c_{stored} is the sound speed stored in the database.

Press key `9` during the measurement to scroll to the display of δc .

```
Flow Velocity
>NORMAL< uncorr.
```

Select `normal` to display and transmit the profile corrected flow values, `uncorr.` to display and output the flow values without flow profile correction. Press ENTER.

For further information see section 13.6.

```
Cut-off Flow
absolut >SIGN<
```

A lower limit for the flow velocity can be entered (see section 13.5).

```
Cut-off Flow
factory >USER<
```

```
Velocity limit
24.0 m/s
```

An upper limit for the flow velocity can be entered (see section 13.4).

Enter 0 (zero) to deactivate the flow velocity check.

```
Heat Quantity
>[J]< [Wh]
```

The heat quantity is the totalizer of the heat flow. Select the unit of measurement for the heat flow (`J` or `Wh`).

```
heat+flow quant.
off >ON<
```

Select `on` to store and output the values of the heat quantity totalizer and the volume totalizer during the heat flow measurement.

```
Quant. wrapping
off >ON<
```

Select the overflow behavior of the totalizers (see section 13.2.1).

```
Quantity recall
off >ON<
```

Select `on` to keep the previous totalizer values after a restart of the measurement.

Select `off` to reset the totalizers to zero after a restart of the measurement.

```
Turbulence mode
off                >ON<
```

The activation of the turbulence mode can improve the signal quality if the flow is highly turbulent (e.g., in the vicinity of an elbow or valve). An SNR value of min. 6 dB is required during the measurement.

Note! The settings will be stored at the end of the dialog.

17.4 Setting the Contrast

```
SYSTEM settings↓
Miscellaneous
```

Select `Special Funct.\SYSTEM settings\Miscellaneous` to set the contrast of the display of the transmitter. Press ENTER.

```
SETUP DISPLAY
← CONTRAST →
```

The contrast of the display is adjusted with the following keys:

- `6` increases the contrast
- `4` reduces the contrast
- `2` = min. contrast
- `5` = medium contrast
- `8` = max. contrast

It is possible to reset the display to medium contrast. Enter HotCode **555000** immediately after the transmitter has been switched on.

Note! After an initialization of the transmitter, the display is reset to medium contrast.

17.5 Instrument Information

```
Special Funct. ↑
Instrum. Inform.
```

Select `Special Funct.\Instrum. Inform.` to display information about the transmitter. Press ENTER.

```
F60X-XXXXXXXX
Free:      18327
```

The type and the serial number of the transmitter is displayed in the upper line.

The available data logger memory will be displayed in the lower line (here: 18 327 additional measured values can be stored). For further information about the data logger see section 14.1.6.

Press ENTER.

```
F60X-XXXXXXXXX
V x.xx dd.mm.yy
```

The type and the serial number of the transmitter is displayed in the upper line.

The firmware version of the transmitter with the date is displayed in the lower line.

Press ENTER.

18 SuperUser Mode

The SuperUser mode offers the possibility of an advanced analysis of the signal and the measured values as well as the definition of additional parameters adapted to the measuring point, in order to achieve better measuring values or during experimental work. Features of the SuperUser mode are:

- Defaults will not be observed.
- There are no plausibility checks when parameters are being entered.
- There is no check whether the entered parameters are within the limits determined by the laws of physics and technical data.
- The cut-off flow is not active.
- A value for the number of sound paths has to be entered.
- Some menu items that are not visible in the normal the normal mode are displayed.

Attention!	The SuperUser mode is intended for experienced users with advanced application knowledge. The parameters can affect the normal measuring mode and lead to wrong measuring values or to a failure of the measurement when a new measuring point is set up.
-------------------	---

18.1 Activation/Deactivation

Enter HotCode **071049** immediately after the transmitter has been switched on.

SUPERUSER MODE *IS ACTIVE NOW*

It is displayed that the SuperUser mode is activated. Press ENTER. The main menu will be displayed.

The SuperUser mode is deactivated by switching off the transmitter.

Attention!	Some of the defined parameters are still active after the deactivation of the SuperUser mode.
-------------------	---

18.2 Transducer Parameters

In the SuperUser mode, the menu item `Transducer Type` will be displayed in the program branch `Parameter` at the end of the input even if the transducers are detected by the transmitter.

Transducer Type↓ Q2E-314

Press ENTER.
or:

Transducer Type↓ Special Version

Select `Special Version` to enter the transducer parameters. Press ENTER.

```
Transd. Data  1
              35.99
```

If `Special Version` is selected, the transducer parameters have to be entered.

The transducer parameters have to be provided by the manufacturer. Press ENTER after each input.

18.3 Defining the Flow Parameters

In the SuperUser mode, it is possible to define some flow parameters (profile bounds, correction of the flow velocity) for the specific application or measuring point.

```
Measuring      ↑
Calibration
```

Select `Special Funct.\SYSTEM settings\ Measuring\Calibration`. Press ENTER.

```
Calibrat. data ↓
for Channel   A:
```

Select the measuring channel for which the flow parameters are to be defined. Press ENTER.

18.3.1 Profile Bounds

```
A:Profile bounds
factory >USER<
```

Select `user` if the profile bounds are to be defined. If `factory` is selected, the default profile bounds will be used and the menu item `Calibration` will be displayed (see section 18.3.2).

Press ENTER.

```
Laminar flow
if R*<      0
```

Enter the max. Reynolds number at which the flow is laminar. The entered number will be rounded to the hundreds. Enter 0 (zero) to use the default value of 1 000.

Press ENTER.

```
Turbulent flow
if R*>      0
```

Enter the min. Reynolds number at which the flow is turbulent. The entered number will be rounded to the hundreds. Enter 0 (zero) to use the default value of 3 000.

Press ENTER.

```
A:Calibration ?
>OFF<      on
```

A request is displayed if an additional correction of the flow velocity is to be defined. Select `on` to define the correction data, `off` to work without correction of the flow velocity and return to the menu item `SYSTEM settings`.

For the definition of the correction of the flow velocity see section 18.3.2.

example: profile bound for the laminar flow: 1 500
 profile bound for the turbulent flow: 2 500
 At Reynolds numbers < 1 500, the flow during the measurement is regarded as laminar for the calculation of the physical quantity. At Reynolds numbers > 2 500, the flow is regarded as turbulent. The range 1 500...2 500 is the transition range between laminar and turbulent flow.

Attention! The defined profile bounds are still active after the deactivation of the SuperUser mode.

18.3.2 Correction of the Flow Velocity

After the profile bounds have been defined (see section 18.3.1), it is possible to define a correction of the flow velocity.

$$v_{\text{cor}} = m \cdot v + n$$

with

- v – measured flow velocity
- m – slope, range: -2.000...+2.000
- n – offset, range: -12.7...+12.7 cm/s
- v_{cor} – corrected flow velocity

All quantities derived from the flow velocity will be calculated with the corrected flow velocity. The correction data are part of the parameter record and will be transmitted to the PC or printer during the online or offline transmission.

Note! During the measurement, it will not be displayed that the correction of the flow velocity is active.

```
A:Calibration ?
off          >ON<
```

Select `on` to define the correction data, `off` to work without correction of the flow velocity and return to the menu item `SYSTEM` settings.

```
A:Slope=
  1.000
```

If `on` is selected, enter the slope. If `0.0` is entered, the correction will be deactivated.
 Press ENTER.

```
A:Offset=
  0.0      cm/s
```

Enter the offset. Enter `0` (zero) to work without an offset.
 Press ENTER.

example 1: Slope: 1.1
 Offset: -10.0 cm/s = -0.1 m/s
 If a flow velocity $v = 5$ m/s is measured, before the calculation of the derived quantities, it will be corrected as follows:
 $v_{cor} = 1.1 \cdot 5 \text{ m/s} - 0.1 \text{ m/s} = 5.4 \text{ m/s}$

example 2: Slope: -1.0
 Offset: 0.0
 Only the sign of the measured values is changed.

Note! The correction data will only be stored when a measurement is started. If the transmitter is switched off without starting a measurement, the entered correction data will be lost.

Attention! The correction of the flow velocity is still active after the deactivation of the SuperUser mode.

18.4 Limit of the Signal Amplification

In order to prevent disturbing and/or pipe wall signals (e.g., if the pipe has run empty) from being interpreted as useful signals, it is possible to define a max. signal amplification. If the signal amplification is greater than the max. signal amplification,

- the flow velocity will be marked as invalid. The physical quantity cannot be determined.
- the LED of the measuring channel will light red
- a hash symbol "#" will be displayed after the unit of measurement (in case of a normal error, "?" is displayed).

Select Special Funct.\SYSTEM settings\Measuring\Miscellaneous. Press ENTER until the menu item `Gain threshold` is displayed.

```
A: Gain threshold
Fail if > 90 dB
```

Enter for each measuring channel the max. signal amplification. Enter 0 (zero) if no limit of the signal amplification is to be used.

Press ENTER.

```
GAIN=91dB→FAIL!
```

The current value of the gain (`GAIN=`) can be displayed in the upper line in the program branch `Measuring`. If the actual value of the gain is higher than the max. gain, the actual value is displayed with `→FAIL!`.

Attention! The limit of the signal amplification is still active after the deactivation of the SuperUser mode.

18.5 Upper Limit of the Sound Speed

When the plausibility of the signal is evaluated, it will be checked if the sound speed is within a defined range. The upper limit of the flow velocity for the fluid is calculated from the greatest of the following values:

- fixed upper value, default: 1 848 m/s
- value of the sound speed curve of the fluid at the operating point plus offset, default offset: 300 m/s

In the SuperUser mode, the values can be defined for fluids that are not contained in the data set of the transmitter. Select `Special Funct.\SYSTEM settings\Measuring\Miscellaneous`. Press ENTER until the menu item `Bad soundspeed` is displayed.

```
A: Bad soundspeed
thresh. 2007 m/s
```

Enter for each measuring channel the fixed upper limit of the sound speed. Enter 0 (zero) to use the default value of 1 848 m/s.

Press ENTER.

```
A: Bad soundspeed
offset: +321 m/s
```

Enter for each measuring channel the offset. Enter 0 (zero) to use the default value of 300 m/s.

Press ENTER.

example: fixed upper value of the sound speed `thresh.:` 2 007 m/s
 `offset:` 600 m/s
 value of the sound speed curve at the operating point: 1 546 m/s
 As $1\,546\text{ m/s} + 600\text{ m/s} = 2\,146\text{ m/s}$ is greater than the fixed upper value 2 007, this value will be used as the upper limit of the sound speed when the plausibility of the signal is evaluated.

```
GAIN=91dB
SS=1038/2146 m/s
```

It is possible to display the valid range for the sound speed (SS=) in the lower line within the program branch `Measuring` during the measurement. The second value (here: 2 146 m/s) is the upper limit at the operating point.

Attention!	The defined upper limit of the sound speed remains active after the deactivation of the SuperUser mode.
-------------------	---

18.6 Detection of Long Measurement Failures

If there are no valid measured value during a long time interval, new increments of the totalizers will be ignored. The values of the totalizers remain unchanged.

In the SuperUser mode, it is possible to set the time interval. Select `Special Funct.\SYSTEM settings\Measuring\Miscellaneous`. Press ENTER until the menu item `Do not total. if no meas.` is displayed.

```
Do not total. if
no meas.>    0 s
```

Enter the time. If 0 (zero) is entered, the default value 30 s will be used.

18.7 Number of Decimal Places of the Totalizers

The totalizer values can be displayed with up to 11 places, e.g., 74890046.03. In the SuperUser mode, it is possible to define the number of decimal places.

Select `Special Funct.\SYSTEM settings\Measuring\Miscellaneous`. Press ENTER until the menu item `Total digits` is displayed.

```
Total digits  ↑
Automatic
```

Select one of the following list items.

Automatic: dynamic adjustment

Fixed to x digit: x decimal places (range: 0...4)

Press ENTER.

Total digits = Automatic

The number of decimal places will be adjusted dynamically. Low totalizer values will first be displayed with 3 decimal places. For higher totalizer values, the number of decimal places will be reduced.

max. value	display
$< 10^6$	±0.000 ... ±999999.999
$< 10^7$	±1000000.00 ... ±9999999.99
$< 10^8$	±10000000.0 ... ±99999999.9
$< 10^{10}$	±1000000000 ... ±9999999999

Total digits = Fixed to x digit

The number of decimal points is constant. The max value of the totalizer is reduced with the number of decimal places.

decimal places	max. value	max. display
0	$< 10^{10}$	±9999999999
1	$< 10^8$	±99999999.9
2	$< 10^7$	±9999999.99
3	$< 10^6$	±999999.999
4	$< 10^5$	±99999.9999

Note! The number of decimal places and the max. value defined here only affect the display of the totalizers.

For setting the behavior of the totalizers when the max. value is reached see section 13.2.1.

18.8 Temperature-Based Heat Flow Cut-Off

With the temperature-based heat flow cut-off, all measured temperature differences between the supply and return line that are lower than a defined value are set to zero. The heat flow is also set to zero. The value of the heat quantity totalizer remains unchanged.

Select Special Funct.\SYSTEM settings\Measuring\Miscellaneous. Press ENTER until the menu item Thermal low cut is displayed.

```
Thermal low cut
off                >ON<
```

Select on to activate the temperature-based heat flow cut-off, off to deactivate it. Press ENTER.

```
Thermal flow ->0
if |dT|< 0.0 C
```

If on is selected, enter the limit of the temperature difference. All temperature differences between the supply and return line that are lower than this value will be set to zero. Enter 0 (zero) to work without the temperature-based heat flow cut-off.

Press ENTER.

18.9 Manual Reset of the Totalizers

If the manual reset of the totalizers is activated, the totalizers can be reset to zero during the measurement by pressing key C 3 times.

Select Special Funct.\SYSTEM settings\Measuring\Miscellaneous. Press ENTER until the menu item 3xC clear totals is displayed.

```
3xC clear totals
off                >ON<
```

Select on to activate the manual reset of the totalizers, off to deactivate it. Press ENTER.

Note!

The manual reset of the totalizers is still active after the deactivation of the SuperUser mode.

18.10 Display of the Sum of the Totalizers

The sum of the totalizers for the two flow directions can be displayed in the upper line during the measurement.

Select Special Funct.\SYSTEM settings\Measuring\Miscellaneous. Press ENTER until the menu item Show ΣQ is displayed..

```
Show  $\Sigma Q$ 
off                >ON<
```

Select on to activate the display of the sum of the totalizers, off to deactivate it. Press ENTER.

```
 $\Sigma Q$           13.2 m3
```

If the display of the sum of the totalizers is activated, the sum ΣQ of the totalizer can be displayed in the upper line during the measurement.

18.11 Display of the Last Valid Measured Value

If the signal is not sufficient for a measurement, usually UNDEF will be displayed. Instead of UNDEF, it is also possible to display the last valid measured value.

Select Special Funct.\SYSTEM settings\Measuring\Miscellaneous. Press ENTER until the menu item Keep display val is displayed.

```
Keep display val
off                >ON<
```

Select on to activate the display of the last valid measured value, off to deactivate it. Press ENTER.

18.12 Display During the Measurement

In the SuperUser mode, the following parameters can be displayed during the measurement besides the normal information (see section 12.3):

display	meaning
t=	transit time of the measuring signal
c=	sound speed
REYNOLD=	Reynolds number
VARI A=	Standard deviation of the signal amplitude
VARI T=	standard deviation of the transit time of the measuring signal
dt-norm=	transit time difference standardized to the transducer frequency
	density of the fluid

19 Wall Thickness Measurement (optional)

If the transmitter has the optional wall thickness measurement, the wall thickness and the longitudinal sound speed of the pipe can be measured. In this case, a wall thickness probe that can be connected directly to the socket of a measuring channel will be included in shipment. The wall thickness probe will be detected automatically when connected to the transmitter. The measured wall thickness can be transmitted directly into the current parameter record.

A modified transit time method is used to determine the wall thickness or the sound speed of the pipe.

- The wall thickness probe emits an ultrasonic pulse which propagates in the pipe.
- The pulse is reflected by the boundary layer of the pipe and received by the wall thickness probe.
- The time difference between emitting and receiving the signal is a measure of the pipe wall thickness (if the sound speed of the material is known) or of the longitudinal sound speed of the pipe (if the wall thickness is known).

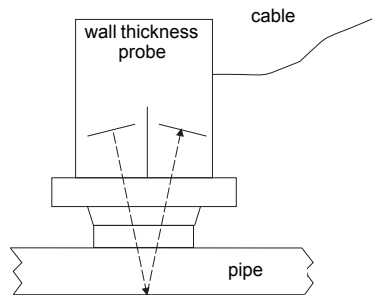

Fig. 19.1: Measurement principle

Note!

With some few exceptions, the transversal sound speed of a material is approx. 30...60 % of the longitudinal sound speed.

19.1 Orientation of the Wall Thickness Probe

When measuring on pipes or cylindrical vessels, the probe has to be pressed centrally against object. The applied pressure has to be constant. The acoustic partition boundary of the wall thickness probe has to be perpendicular to the longitudinal axis of the pipe (see Fig. 19.2).

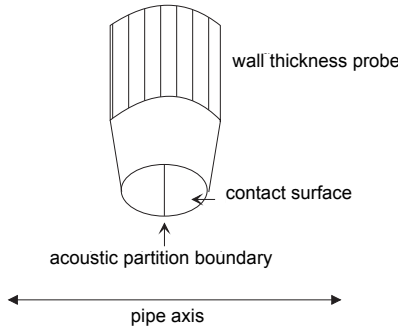

Fig. 19.2: Acoustic partition boundary

19.2 Activation of the Wall Thickness Measurement

Connect the wall thickness probe to the measuring channel A or B. The wall thickness measuring mode is activated automatically.

```
*WALL THICKNESS*
*DETECTED ON A:*
```

A message is displayed that the wall thickness probe has been detected.

The main menu of the wall thickness measurement is displayed. The menu structure is similar to the structure of the flow measurement. The program branches are adapted to the wall thickness measurement.

Note! The wall thickness measurement mode will remain activated as long as the wall thickness probe is connected to the measuring channel.

19.3 Parameter Input

19.3.1 Parameter Input for the Wall Thickness Measurement

The sound speed of the pipe material has to be entered to measure the wall thickness.

```
Physic. Quant. ↓
Wall Thickness
```

Select `Wall Thickness` in `Output Options\Physic. Quant.` for the measuring channel to which the wall thickness probe is connected.

```
Pipe Material ↓
Carbon Steel
```

Select the pipe material in `Parameter\Pipe Material`. If the material is not in the list, select `Other Material`. Press ENTER.

```
c-LONGITUDINAL
5800.0      m/s
```

A value for the longitudinal sound speed of the selected material is recommended.

If `Other Material` has been selected, 0.0 m/s will be displayed.

Enter the sound speed, if necessary. Press ENTER.

Note!

The measurement can only be started if the entered sound speed is > 0.

Compared to the flow measurement, the sound speed has a great, approximately linear influence on the measuring result. If a sound speed that is 10 % too high is entered, the measured wall thickness will be approx. 10 % greater than the actual wall thickness.

The actual sound speed of a material often differs substantially from the values published in the literature as it depends on the composition, the manufacturing process and the temperature. The sound speeds given in annex C.1 only serve as an orientation.

Note!

The longitudinal sound speed of a material can be measured precisely using a comparative block of known thickness (see section 19.4.2).

19.3.2 Parameter Input for the Sound Speed Measurement

The thickness of the pipe has to be entered to determine the longitudinal sound speed of a material.

```
Physic. Quant. ↑
c-LONGITUDINAL
```

Select in `Output Options\Physic. Quant.` the physical quantity `c-LONGITUDINAL` for the measuring channel to which the wall thickness probe is connected.

```
Wall Thickness
5.12      mm
```

Select `Parameter\Wall Thickness`. Enter the pipe wall thickness.

19.4 Measurement

```
par >MEA< opt sf
Measuring
```

In the main menu, select the program branch `Measuring`. Press ENTER.

```
par >MEA< opt sf
NO DATA!
```

This error message will be displayed if the entered parameters are not complete.

19.4.1 Measurement of the Wall Thickness

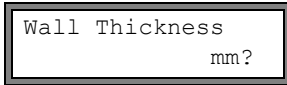

This display is indicated if the wall thickness is selected as the physical quantity for the measuring channel connected to the probe.

As long as there is no valid measured value, the unit of measurement and a question mark will be displayed in the lower line.

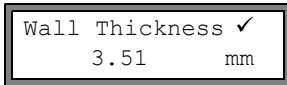

Apply a thin film of the coupling compound to the pipe wall. Press the wall thickness probe against the pipe wall in this position.

As soon as a valid measured value is obtained, it will be displayed in the lower line. A tick will be displayed in the upper line on the right.

The measured value remains on the display when the wall thickness probe is removed from the pipe.

To minimize errors when measuring the wall thickness, measure the longitudinal sound speed of the material on a reference object of the same material with known dimensions.

- The reference object should be even and smooth.
- The thickness of the reference object should be comparable to the max. thickness of the pipe.

Note!	The sound speed of the material depends on the temperature. Therefore, the sound speed of a reference object should be measured at the place where the flow will be measured later to obtain the sound speed at the correct temperature.
--------------	--

19.4.2 Measurement of the Sound Speed

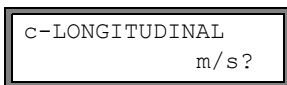

This display will be indicated if the sound speed is selected as physical quantity for the measuring channel connected to the wall thickness probe.

As long as there is no valid measured value, the unit of measurement and a question mark will be displayed in the lower line of the display.

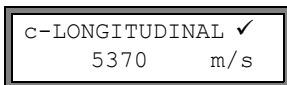

Apply a thin film of the coupling compound to the pipe wall. Press the wall thickness probe against the pipe wall in this position.

As soon as a valid measured value is obtained, it will be displayed in the lower line. A tick will be displayed in the upper line on the right.

The measured value remains on the display when the wall thickness probe is removed from the pipe.

Note! For pipe materials whose longitudinal sound speed can be used for the measurement of the volumetric flow rate see annex C.1.

19.4.3 Further Information on the Measurement

SIGNAL IS GOOD
3.51 mm

Press key 9 to obtain information on the measuring signal.

This message will be displayed if the measuring signal is sufficient. The LED of the channel will light green.

ERRORSIGNAL #
mm?

This message will be displayed if the measuring signal is not sufficient (# = number). The LED of the measuring channel will light red.

Q=■■■■■■■

Press key 9 again. The bar graph of the signal quality (Q=) will be displayed.

If the signal is not sufficient for measurement, UNDEF will be displayed. The LED of the measuring channel will light red. Shift the wall thickness probe slightly on the pipe until the LED of the measuring channel lights green.

Wall Thickness
LZ= 186 ns

Press key 3 to display the transit time of the signal.

19.4.4 Errors during the Measurement

If no valid wall thickness can be measured,

- remove the wall thickness probe from the pipe wall
- clean the wall thickness probe and the position on the pipe where the measurement takes place
- apply a thin film of the coupling compound to the pipe wall
- press the wall thickness probe against the pipe wall in this position
- try measuring again

Note! Use a small amount of coupling compound. Press the wall thickness probe evenly against the pipe wall.

19.4.5 Possible Reasons for Incorrect Measuring Results

• **temperature fluctuations:**

The sound speed is temperature dependent.

• **doubling effect:**

When measuring the wall thickness using ultrasonic signals, a phenomenon called the doubling effect can occur if the wall thickness is smaller than the min. measuring range of the probe. The measured value is then twice (or sometimes three times) as high as the actual wall thickness because of repeated reflections of the ultrasonic signal.

- **the measured value is too low:**

The ultrasonic signal was reflected by a defect and not by the boundary layer, resulting in a shorter transit time and therefore a lower wall thickness.

- **warped surfaces:**

The probe has to be pressed centrally against the pipe or cylindrical vessel. The applied pressure has to be constant. The acoustic partition boundary of the wall thickness probe has to be perpendicular to the longitudinal axis of the pipe (see Fig. 19.2).

- **surface conditions:**

Regular unevenness (e.g., small grooves) on the surface of the pipe can result in wrong measured values. Normally, this problem can be avoided by turning the wall thickness probe in such way that the acoustic partition boundary of the pipe is perpendicular to the orientation of the grooves (see Fig. 19.2).

When measuring on a rough surface, applying too much of the coupling compound can result in wrong measured values. A measurement on a very rough surface might be impossible (message NO COUPLING will be displayed). In this case, the surface has to be smoothed.

19.4.6 Storing/Transmission of the Wall Thickness

Press ENTER to stop the measurement and to store or output the measured value. The following display appears if a valid wall thickness has been measured and a transmission of measured value is activated:

```

Transfer Data
no           >YES<
  
```

Select *yes* to store and/or output the measured value.

- The wall thickness can be transmitted into the current parameter record.
- The pipe material will be replaced by the material used for the wall thickness measurement.

If the serial transmission is activated, the measured value will be transmitted.

19.4.7 Stop of the Wall Thickness Measurement

To quit the wall thickness measurement mode, disconnect the wall thickness measurement from the transmitter.

20 Heat Flow Measurement

If the transmitter has the optional heat quantity measurement and two temperature inputs, the heat flow can be measured. A temperature probe is fixed on the supply and the return line.

For the mounting of the temperature probe see chapter 9.

The transducers are fixed on the return line (see Fig. 20.1). If this is not possible, they can also be mounted on the supply line (see Fig. 20.2).

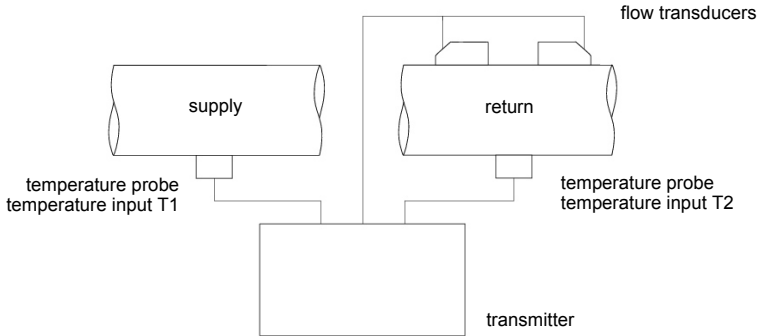

Fig. 20.1: Heat flow measurement with flow measurement on the return line

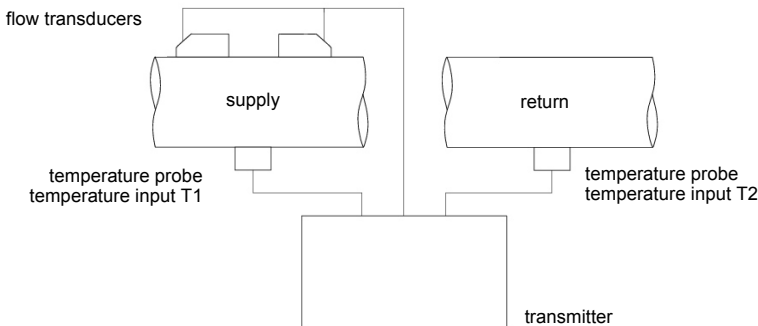

Fig. 20.2: Heat flow measurement with flow measurement on the supply line

For the heat flow measurement, two different measuring modes can be used:

- The normal measuring mode (see section 20.2) can be used if in a heating application the flow transducers are mounted on the return line.

- The BTU mode (see section 20.3) facilitates the measurement with other configurations (e.g., if the flow transducers are mounted on the supply line or in a cooling application) and offers additional units of measurement for the heat flow.

A temperature correction value (offset) can be defined for each temperature input (see section 21.5).

If the supply or return temperature is known and constant during the whole measurement, this temperature can be entered in the transmitter as a constant value. In this case, the corresponding temperature probe does not need to be connected (see section 20.2.3 or 20.3.3).

If the supply pressure is constant or can be measured with an additional input, the heat flow can be determined for a fluid that is vaporous in the supply line (see section 20.6).

In the SuperUser mode, it is possible to define a temperature-based cut-off flow of the heat flow (see section 18.8).

The heat quantity is the totalizer of the heat flow (see section 13.2).

20.1 Calculation of the Heat Flow

The heat flow is calculated by the following formula:

$$\Phi = k_i \cdot \dot{V} \cdot (T_V - T_R)$$

with

Φ – heat flow rate

k_i – heat coefficient

\dot{V} – volumetric flow rate

T_V – supply temperature

T_R – return temperature

The heat coefficient k_i is calculated from 10 heat flow coefficients for the specific enthalpy and the density of the fluid. The heat coefficients of some fluids are stored in the internal database of the transmitter. The heat flow coefficients of other fluids have to be entered before the start of the measurement (see section 16.3.4).

20.2 Normal Measuring Mode

The supply and return temperature are assigned to the measuring channels as $T_{\text{-Inlet}}$ and $T_{\text{-Fluid/Outlet}}$. The temperatures can be measured or entered as constant values.

20.2.1 Flow Measurement on the Return Line

The temperature inputs (see Fig. 20.1) are configured as follows:

```
Proc. inputs  ↓
Link temperature
```

Select Special Funct.\SYSTEM settings\Proc. inputs\Link temperature. Press ENTER.

```
A:T-Inlet    ↓
Input T1
```

Select the list item Input T1 to assign the temperature probe on the supply line to the temperature input T1. Press ENTER.

```
A:T-Fluid/Outle;
Input T2
```

Select the list item Input T2 to assign the temperature probe on the return line to the temperature input T2. Press ENTER.

20.2.2 Flow Measurement on the Supply Line

The temperature inputs (see Fig. 20.2) are configured as follows:

```
Proc. inputs  ↓
Link temperature
```

Select Special Funct.\SYSTEM settings\Proc. inputs\Link temperature. Press ENTER.

```
A:T-Inlet    ↓
Input T2
```

Select the list item Input T2 to assign the temperature probe on the supply line to the temperature input T2 (even though it is connected to the temperature input T1!). Press ENTER.

```
A:T-Fluid/Outle;
Input T1
```

Select the list item Input T1 to assign the temperature probe on the return line to the temperature input T1 (even though it is connected to the temperature input T2!). Press ENTER.

```
A:Heatflow   ↓
-123.45 kW
```

The measuring values of the heat flow will be displayed with the opposite sign during the measurement.

The sign of the measured values is changed by

- switching the flow transducers
- switching the temperature probes (leads to an additional measuring error)
- entering the slope -1.0 in the correction formula of the flow velocity (see section 18.3.2).

20.2.3 Input of a Constant Temperature

If the supply or return temperature is known and constant during the whole measurement, this temperature can be entered in the transmitter as a constant value.

Note! A constant temperature should be entered if, e.g., the supply temperature can only be measured with difficulty but is known and constant.

The temperature inputs are configured as follows:

```
Proc. inputs  ↓
Link temperature
```

Select `Special Funct.\SYSTEM settings\Proc. inputs\Link temperature`. Press ENTER.

```
A:T-Inlet    ↓
Fixed input val.
```

Select the list item `Fixed input val.` if the supply temperature is known and constant.

Press ENTER.

```
A:T-Fluid/Outlet ↓
Fixed input val.
```

Select the list item `Fixed input val.` if the return temperature is known and constant.

Press ENTER.

Repeat the steps for all measuring channels on which a measurement is being made.

The constant value of the temperature is entered before the start of the measurement in the program branch `Measuring` (see section 20.4).

20.2.4 Defining the Physical Quantity and the Unit of Measurement

- Select the program branch `Output Options`.

```
Output Options ↓
for Channel  A:
```

Select the measuring channel on which the heat flow is to be measured (the channel to which the temperature inputs have been assigned). Press ENTER.

This display will not be indicated if the transmitter has only one measuring channel.

```
Physic. Quant. ↓
Heatflow
```

Select `Heatflow` as the physical quantity. Press ENTER.

```
Heatflow    ↓
kW
```

Select the unit of measurement to be used for the heat flow.

Note! The physical quantity `Heatflow` will only be displayed in the program branch `Output Options` of a measuring channel if the supply and return temperature have been assigned to this channel.

- If the heat quantity is also to be measured, select `Special Funct.\SYSTEM settings\Measuring`. Press `ENTER` until the list item `Heat Quantity` is displayed.

```
Heat Quantity
>[J]<           [Wh]
```

Select the unit of measurement (`J` or `Wh`). Press `ENTER`.

20.3 BTU Mode

The BTU mode is a measuring mode that is designed specifically for the heat flow measurement. In the BTU mode, the position of the flow transducers and the application can be assigned to avoid receiving the opposite sign of the measured values.

20.3.1 Activation/Deactivation of the BTU Mode

Enter `HotCode 007025` immediately after the transmitter has been switched on.

```
Act as BTU-meter
>OFF<           on
```

Select `on` to activate the BTU mode, `off` to deactivate it. Press `ENTER`.

Note! The BTU mode remains active after a restart of the transmitter.

20.3.2 Assignment of the Flow Transducers and the Temperature Inputs

The position of the flow transducers and the temperature inputs can be assigned in accordance with the application.

Select `Special Funct.\SYSTEM settings\Proc. inputs\Link temperature`.

```
A:Thermal energy
>HEAT<           chill
```

In case of a heating application, select `heat`, in case of a cooling application, select `chill`. Press `ENTER`.

```
Transd. Location
>RETURN<        supply
```

Select `return` if the flow transducers are mounted on the return line or `supply` if the flow transducers are mounted on the supply line. Press `ENTER`.

```
Thermal energy
>ABSOLUTE<  sign
```

Select `sign` if the sign of the heat flow is to be considered, `absolute`, if the absolute value of the heat flow is to be displayed. Press ENTER.

```
A:T-Supply    ↑
Input T1
```

Select the temperature input to be assigned to the supply temperature. Press ENTER.

```
A:T-Return    ↑
Input T2
```

Select the temperature input to be assigned to the return temperature.

Press ENTER.

20.3.3 Input of a Constant Temperature

If the supply or return temperature is known and constant during the whole measurement, this temperature can be entered in the transmitter as a constant value.

Note!

A constant temperature should be entered if, e.g., the supply temperature can only be measured with difficulty but is known and constant.

The temperature inputs are configured as follows:

```
Proc. inputs  ↑
Link temperature
```

Select `Special Funct.\SYSTEM settings\Proc. inputs\Link temperature`. Press ENTER.

```
A:T-Supply    ↑
Fixed input val.
```

Select the list item `Fixed input val.` if the supply temperature is known and constant.

Press ENTER.

```
A:T-Return    ↑
Fixed input val.
```

Select the list item `Fixed input val.` if the return temperature is known and constant.

Press ENTER.

Repeat the steps for all measuring channels on which a measurement is being made.

The constant value of the temperature is entered before the start of the measurement in the program branch `Measuring` (see section 20.4).

20.3.4 Defining the Physical Quantity and of the Unit of Measurement

- Select the program branch `Output Options`.

```
Output Options ↓
for Channel A:
```

Select the measuring channel on which the heat flow is to be measured (the channel to which the temperature inputs have been assigned). Press ENTER.

This display will not be indicated if the transmitter has only one measuring channel.

```
Physic. Quant. ↓
Thermal energy
```

Select `Thermal energy` as the physical quantity. Press ENTER.

```
Thermal energy ↓
kW
```

Select the unit of measurement to be used for the heat flow.

In the BTU mode, additional units of measurement are available for the heat flow and the heat quantity (see section 13.2). The unit of measurement displayed during the measurement will be adjusted automatically:

unit of measurement of the heat flow	unit of measurement of the heat quantity
kBTU/min	kBTU
kBTU/h	kBTU
MBTU/h	MBTU
kBTU/day	kBTU
TON (TH)	TH
TON (TD)	TD
kTON (kTH)	kTH
kTON (kTD)	kTD

20.4 Measurement

Start the measurement as usual.

```
Heatflow
*INVALID MEDIUM*
```

If no heat flow coefficients are available for the selected fluid, an error message will be displayed. For the input of the heat flow coefficient see section 16.3.4.

```
T1= 90.2 C
T2= 70.4 C
```

The two temperature inputs are checked and the measured temperatures are displayed.

```
T1=?UNDEF      C
T2= 70.4       C
```

If a temperature cannot be measured (the temperature probe is not connected or is defective), the error message ?UNDEF will be displayed.

```
A:Ts manualFIX
      0.0       C
```

If Fixed input val. is selected during the configuration of the temperature input, the temperature input (T_s) or the return temperature (T_r) will have to be entered now.

For simulations, it is possible to enter both the supply and return temperatures as constants. In this case, do not connect the temperature probes to the transmitter.

Enter the fluid temperature. Press ENTER.

```
A:Heatflow
      0.4       kW
```

The measured heat flow (in BTU mode Thermal energy) is displayed.

For the activation of the heat flow totalizer see section 13.2.

20.5 Two independent Heat Flow Measurements

If the transmitter has 2 measuring channels and 2 temperature inputs for each measuring channel, it is possible to conduct 2 independent heat flow measurements at the same time. Tab. 20.1 shows a typical configuration of the temperature inputs.

Tab. 20.1: Configuration of the temperature inputs in case of two independent heat flow measurements

	temperature input
measuring channel A	
supply temperature	T1 or constant value
return temperature	T2 or constant value
heat quantity measurement	possible
measuring channel B	
supply temperature	T3 or constant value
return temperature	T4 or constant value
heat quantity measurement	possible

20.6 Steam in Inlet

If the supply pressure is constant or can be measured with an additional input, the heat flow can be determined for a fluid that is vaporous in the supply line.

The state of aggregation of the fluid is determined by means of the supply pressure and the supply temperature.

Note! The measurement of the volumetric flow rate and the heat flow is only possible if the fluid is liquid in the return line.

The steam coefficient of water and ammonia are stored in the internal database of the transmitter. The steam coefficient of other fluids have to be entered with the program FluxKoef.

20.6.1 Activation/Deactivation

```
SYSTEM settings;
Dialogs/Menu
```

Select Special Funct.\SYSTEM settings\Dialogs/Menu\Steam in inlet.

```
Steam in inlet
off >ON<
```

Select on to activate Steam in inlet. The state of aggregation of the fluid is determined by means of the supply pressure and the supply temperature of the fluid.

Select off to deactivate Steam in inlet. The fluid is then always considered to be liquid in the supply line.

```
Inlet pressure
10.0 bar
```

If Steam in inlet is activated, the supply pressure has to be entered in the program branch Parameter.

Enter the supply pressure. Press ENTER.

Note! The menu item Steam in inlet will always be displayed independently of the selected physical quantity. However, the supply pressure will only be used for the heat flow measurement.

20.6.2 Display of the State of Aggregation

During the heat flow measurement, the state of aggregation of the fluid can be displayed in the upper line by pressing the key 9.

display	meaning
S=	state of aggregation in the supply line
R=	state of aggregation in the return line
GAS	The fluid is completely gaseous.
LIQU	The fluid is completely liquid.
BOIL	<p>The fluid is in the phase transition.</p> <p>In this case, an exact measurement of the heat flow is not possible because the proportion of the fluid in liquid phase in the supply line has to be known in order to calculate the enthalpy of the supply.</p> <p>The critical range of water is defined as the range ± 3 °C around the boiling temperature. In the critical range, the steam saturation enthalpy is used to calculate the heat flow.</p>

example:

A: S= GAS R= LIQU 426.23 kW

The fluid in the supply line is completely gaseous. The fluid in the return line is completely liquid. A heat flow measurement is possible.

21 Inputs

External transducers can be connected to the inputs (optional) to measure the following physical quantities:

- temperature
- density (FLUXUS F601)
- pressure (FLUXUS F601)
- kinematic viscosity (FLUXUS F601)
- dynamic viscosity (FLUXUS F601)

The values of the current and voltage inputs (FLUXUS F601) and temperature inputs can be used by all measuring channels.

An input has to be assigned to a measuring channel (see section 21.1 and 21.3) and activated (see section 21.4) before it can be used for the measurement and for the storing of measured values.

```
SYSTEM settings↓
Proc. inputs
```

Select Special Funct.\SYSTEM settings\Proc. inputs.

Depending on the configuration of the transmitter, one or several of the following list items will be displayed:

Tab. 21.1: List items for Proc. inputs

list item	function
Link temperature	assignment of temperature inputs to measuring channels
Link other inp.	assignment of other inputs to measuring channels
PT100/PT1000	selection of a temperature probe
...go back	return to the previous menu item

21.1 Assignment of the Temperature Inputs to the Measuring Channels

21.1.1 Temperature Inputs and the Heat Flow Measurement

For the heat flow measurement, the supply and return temperature have to be assigned to the corresponding measuring channel as T-Inlet and T-Fluid/Outlet (see section 21.1.2). These temperatures are usually measured, but can also be entered as constants.

21.1.2 Assignment of the Temperature Inputs

```
SYSTEM settings↓
Proc. inputs
```

Select Special Funct.\SYSTEM settings\Proc. inputs. Press ENTER.

```
Proc. inputs  ↓
Link temperature
```

Select the list item `Link temperature`.

```
A:T-Inlet    ↓
Input T1
```

Select the temperature input to be assigned to measuring channel A as supply temperature.

Select the list item `Fixed input val.` if the temperature is to be entered manually before the measurement.

Select the list item `No measuring` if no supply temperature is to be assigned to measuring channel A.

Press ENTER.

Select the list items for `T-Fluid/Outle`, `T(3)` and `T(4)` of measuring channel A and the other activated channels accordingly. Press ENTER after each input.

Note!	The configuration of a measuring channel will be stored when the next channel is selected. The configuration dialog for a channel has to be completed in order to store the changes.
--------------	--

21.2 Selection of the Temperature Probe

```
SYSTEM settings↓
Proc. inputs
```

Select `Special Funct.\SYSTEM settings\Proc. inputs`. Press ENTER.

```
Proc. inputs  ↓
PT100 / PT1000
```

Select the list item `PT100 / PT1000`.

```
Input T1      ↓
>PT100<      pt1000
```

Select the temperature probe.

If necessary, select the temperature probe for `Input T2...T4` accordingly.

21.3 Assignment of other Inputs to the Measuring Channels

```
SYSTEM settings↓
Proc. inputs
```

Select `Special Funct.\SYSTEM settings\Proc. inputs`. Press ENTER.

```
Proc. inputs  ↓
Link other inp.
```

Select the list item `Link other inp..`

```
A:ext.Input(1)
Input I1
```

Select the first input to be assigned to measuring channel A. Only the installed inputs are displayed in the scroll list.

Select the list item `No measuring` if no input is to be assigned to measuring channel A.

Press ENTER.

Select the list items for `ext.Input(2)...`(4) of measuring channel A and the other activated channels accordingly.

Note!

The configuration of a measuring channel will be stored when the next channel is selected. The configuration dialog for a channel has to be completed in order to store the changes.

21.4 Activation of the Inputs

The activation of the inputs in program branch `Output Options` will only be displayed if the transmitter has inputs of the corresponding type and they have been assigned to a measuring channel.

21.4.1 Activation of the Temperature Inputs

Note!

If `Heatflow` is selected as the physical quantity, the corresponding temperature inputs will be activated automatically. The steps described below are only necessary if the measured temperatures are to be displayed or transmitted.

Temperature inputs have to be activated if the measured temperatures are to be displayed, stored and/or transmitted or if the measured temperature is to be used for the interpolation of the viscosity and the density of the fluid.

```
Temperature T1
no >YES<
```

Select in the program branch `Output Options` the channel for which a temperature input has to be activated.

The temperature inputs assigned to the channel will be displayed one after another. Select `yes` for the temperature inputs that are to be activated.

Note!

The total number of measured values that can be stored will be reduced if a temperature input is activated.

21.4.2 Activation of other Inputs

Attention! Observe the correct polarity to avoid damaging the current source. The current input might be destroyed by a permanent short circuit.

Inputs have to be activated if the measured values are to be displayed, stored and/or transmitted together with the other measured values.

```
Input      I1
no         >YES<
```

In the program branch `Output Options`, select the channel for which an input is to be activated.

The inputs assigned to the channel will be displayed one after another. Select `yes` for the inputs that are to be activated.

Note! The total number of measured values that can be stored will be reduced if an input is activated.

21.5 Temperature Correction

A temperature correction value (offset) can be set for each temperature input. If a correction value has been defined, it will be added automatically to the measured temperature. This function is useful if e.g.:

- the characteristic curves of the two temperature probes differ considerably from each other.
- a known and constant temperature gradient exists between the measured temperature and the actual temperature.

21.5.1 Activation/Deactivation of the Temperature Correction

The temperature correction can be activated/deactivated in program branch `Special Funct.\SYSTEM settings\Dialogs/Menu`.

```
Tx Corr.Offset
off             >ON<
```

Select `on` to activate the temperature correction, `off` to deactivate it.

Note! If `off` is selected, the temperature correction will be deactivated for all inputs. However, the entered correction values for each temperature input will be stored and displayed again when the temperature correction is activated again.

21.5.2 Input of the Temperature Correction

During the flow transducer positioning, the correction values will be requested for each input which has been activated and where the temperature can be measured.

```
T1 Corr.Offset
0.3          C
```

Enter the offset for the temperature input.
Press ENTER.

Note!

Only measured temperatures can be corrected.

In order to adjust the zero point, the same reference temperature is measured with the two temperature probes. The difference between the two measured temperatures is entered as the offset for one of the temperature inputs. The difference can also be distributed between the offsets of the two channels.

The display of the temperature difference T1-T2 does not indicate if one or both temperatures are constant or if the values have been corrected.

```
T1= 90.5 C (COR)
      0.0      kW
```

During the measurement, a corrected temperature value is marked by `cor.`

22 Outputs

If the transmitter is equipped with outputs, they have to be installed and activated before they can be used:

- assign a measuring channel (source channel) to the output (if the transmitter has more than one measuring channel)
- assign the physical quantity (source item) to be transmitted to the output by the source channel, and the properties of the signal
- define the behavior of the output in case no valid measured values are available
- activation of the installed output in the program branch `Output Options`

22.1 Installation of an Output

All outputs are installed in `Special Funct.\SYSTEM settings\Proc. outputs.`

Note! The settings will be stored at the end of the dialog. If the menu item is quit by pressing key `BRK`, the changes will not be stored.

```
SYSTEM settings↓
Proc. outputs
```

Select `Special Funct.\SYSTEM settings\Proc. outputs.` Press `ENTER`.

```
Install Output ↓
Current I1 (✓)
```

Select the output to be installed. Press `ENTER`.

The scroll list contains all actually available outputs. A tick (✓) after a list item indicates that this output has already been installed.

```
I1 enable
no >YES<
```

This display will be indicated if the output has not been installed yet. Select `yes`. Press `ENTER`.

```
I1 disable
>NO< yes
```

If the output has already been installed, select `no` to reconfigure it or `yes` to uninstall the output and to return to the previous menu item to select another output. Press `ENTER`.

```
I1 Source chan.↓
Channel A:
```

Select in the scroll list the measuring channel to be assigned as source channel to the output. Press `ENTER`.

This display will not be indicated if the transmitter has only one measuring channel.

```
I1 Source item ↓
Measuring value
```

Select the physical quantity (source item) to be transmitted to the output by the source channel.

If a binary output is configured, only the list items `Limit` and `Impuls` will be displayed.

The source items and their scroll lists are described in Tab. 22.1.

Tab. 22.1: Configuration of the outputs

source item	list item	output
Measuring value	actual measure	physical quantity selected in the program branch Output Options
	Flow	flow, independently of the physical quantity selected in the program branch Output Options
	Heatflow	heat flow, independently of the physical quantity selected in the program branch Output Options
Quantity	Q+	totalizer for the positive flow direction
	* actual measure	totalizer for the physical quantity selected in the program branch Output Options
	* Flow	flow totalizer
	* Heatflow	totalizer for the heat flow
	Q-	flow totalizer for the negative flow direction
	* actual measure	totalizer for the physical quantity selected in the program branch Output Options
	* Flow	flow totalizer
	* Heatflow	totalizer for the heat flow
	ΣQ	sum of the totalizers (positive and negative flow direction)
	* actual measure	totalizer for the physical quantity selected in the program branch Output Options
	* Flow	flow totalizer
	* Heatflow	totalizer for the heat flow

Tab. 22.1: Configuration of the outputs

source item	list item	output
Limit	R1	limit message alarm output R1)
	R2	limit message (alarm output R2)
	R3	limit message (alarm output R3)
Temperature	Is only available if a temperature input has been assigned to the channel.	
	Tfluid ← (Ti) *	fluid temperature of the temperature probes at the point where the flow is measured
	Taux S/R← (Ti) *	fluid temperature of the other temperature probe
	Tsupply ← (Ti) *	supply temperature
	Treturn ← (Ti) *	return temperature
	Ts-Tr (Ti-Tj) *	difference supply temperature-return temperature
	Tr-Ts (Ti-Tj) *	difference return temperature-supply temperature
	T(3) ← (Ti) *	3. temperature input of the measuring channel
	T(4) ← (Ti) *	4. temperature input of the measuring channel
* i, j: number of the assigned temperature input		
Impuls	from abs(x)	pulse without sign consideration
	from x > 0	pulse for positive measured values
	from x < 0	pulse for negative measured values
Miscellaneous	c-Medium	sound speed of the fluid
	Signal	signal amplitude of a measuring channel
	SCNR	ratio useful signal to correlated disturbance signal
	VariAmp	standard deviation of the signal amplitude
	Density	density of the fluid

22.1.1 Output Range

```
I1 Output range↓
  4/20 mA
```

When configuring an analog output, the output range will be defined now. Select a list item or `other range` to enter the output range manually.

```
I1 Output MIN ↓
  10.0 mA
```

If `other range` is selected, enter the values `Output MIN` and `Output MAX`. Press `ENTER` after each input.

```
I1 Output MAX ↓
  11.0 mA
```

```
I1 Output MAX ↓
  12.0 MINIMAL
```

This error message will be displayed if the output range is not min. 10 % of the max. output range. The next possible value will be displayed. Repeat the input.

example: $I_{MAX} - I_{MIN} \geq 2 \text{ mA}$ for a 4...20 mA current output

22.1.2 Error Value

In the following dialog, an error value can be defined which is to be transmitted if the source item cannot be measured, e.g., if there are gas bubbles solids in the fluid.

Tab. 22.2: Error output

error value	results
Minimum	output of the lower limit of the output range
Hold last value	the last measured value is transmitted
Maximum	output of the upper limit of the output range
Other value...	The value has to be entered manually. It has to be within the limits of the output.

example:

source item: volumetric flow rate
 output: current output
 output range: 4...20 mA
 error value delay t_d (see section 22.2): > 0

The volumetric flow rate cannot be measured during the time interval $t_0...t_1$ (see Fig. 22.1). The error value will be transmitted.

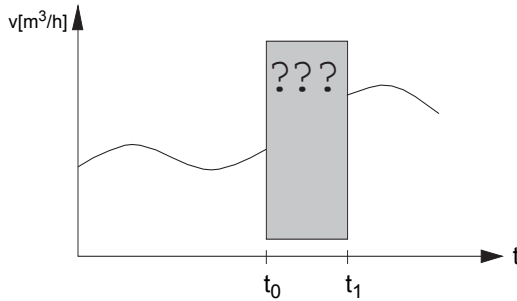
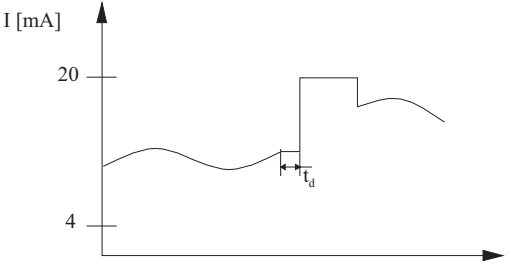
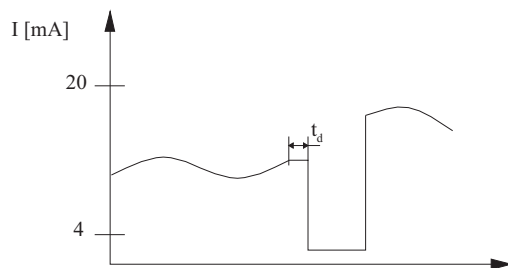

Fig. 22.1: Error output

Tab. 22.3: Examples for the error output

list item for the error output	output signal
<div style="border: 1px solid black; padding: 5px; width: fit-content;"> Error-value \updownarrow Minimum (4.0mA) </div>	<p>The graph shows the current output I in mA over time t. The y-axis has markers at 4 and 20 mA. The signal follows a wavy pattern, then drops sharply to 4 mA during a period labeled t_d, before returning to a higher value.</p>
<div style="border: 1px solid black; padding: 5px; width: fit-content;"> Error-value \updownarrow Hold last value </div>	<p>The graph shows the current output I in mA over time t. The y-axis has markers at 4 and 20 mA. The signal follows a wavy pattern and then holds its last value (a constant level) during the error interval, before rising again.</p>

Tab. 22.3: Examples for the error output

list item for the error output	output signal
<div style="border: 1px solid black; padding: 5px; margin-bottom: 10px;"> Error-value ↓ Maximum (20.0mA) </div>	
<div style="border: 1px solid black; padding: 5px; margin-bottom: 10px;"> Error-value ↓ Other value... </div> <p>error output = 2 mA</p>	

Error-value ↓
 Minimum (4.0mA)

Select a list item for the error output. Press ENTER.

Error-value ↓
 3.5 mA

If `Other value` is selected, enter an error value. It has to be within the limits of the output.
 Press ENTER.

Note! The settings will be stored at the end of the dialog.

22.1.3 Function Test

The function of the installed output can now be tested. Connect a multimeter to the installed output.

Test of the Analog Outputs

```
I1:Output Test
      4      mA
```

The current output is tested in the display. Enter a test value. It has to be within the output range. Press ENTER.

```
I1= 4.0 mA
Again? no >YES<
```

If the multimeter displays the entered value, the output functions correctly.

Select `yes` to repeat the test, `no` to return to `SYSTEM` settings. Press ENTER.

Test of the Binary Outputs

```
B1:Output Test ↓
Reed-Relay OFF
```

Select `Reed-Relay OFF` or `Open collect OFF` in the scroll list `Output Test` to test the de-energized state of the output. Press ENTER. Measure the resistance at the output. The value has to be high ohmic.

```
B1=OFF
Again? no >YES<
```

Select `yes`. Press ENTER.

```
B1:Output Test ↓
Reed-Relay ON
```

Select `Reed-Relay ON` or `Open collect`. `ON` in the scroll list `Output Test` to test the energized state of the output. Press ENTER. Measure the resistance at the output. The value has to be low ohmic.

```
B1=ON
Again? no >YES<
```

Select `yes` to repeat the test, `no` to return to `SYSTEM` settings. Press ENTER.

22.2 Error Value Delay

The error value delay is the time interval after which the error value is transmitted to the output in case no valid measured values are available. The error value delay can be entered in the program branch `Output Options` if this menu item has previously been activated in the program branch `Special Funct..`

```
Error-val. delay
>DAMPING<   edit
```

Select `Special Funct.\SYSTEM settings\ Dialogs/Menus/Error-val. delay`.

Select `damping` if the damping factor is to be used as the error value delay. Select `edit` to activate the menu item `Error-val. delay` in the program branch `Output Options`.

```
Error-val. delay
   10      s
```

From now on, the error value delay can be entered in the program branch `Output Options`.

22.3 Activation of an Analog Output

Note! An output can only be activated in the program branch `Output Options` if it has previously been installed.

```
Output Options ↑
for Channel  A:
```

In the program branch `Output Options`, select the channel for which an output is to be activated. Press `ENTER`.

This display will not be indicated if the transmitter has only one measuring channel.

```
Current Loop
I1: no      >YES<
```

Press `ENTER` until `Current Loop` is displayed. Select `yes` to activate the output. Press `ENTER`.

22.3.1 Measuring Range of the Analog Outputs

After an analog output has been activated in the program branch `Output Options`, the measuring range of the source item has to be entered.

```
Meas.Values
>ABSOLUT<   sign
```

Select `sign` if the sign of the measured values is to be considered for the output.

Select `absolut` if the sign is not to be considered.

```
Zero-Scale Val.
   0.00     m3/h
```

Enter the lowest expected measured value. The unit of measurement of the source item will be displayed.

`Zero-Scale Val.` is the measured value corresponding to the lower limit of the output range as defined in section 22.1.1.

```
Full-Scale Val.
   300.00   m3/h
```

Enter the highest expected measured value.

`Full-Scale Val.` is the measured value corresponding to the upper limit of the output range as defined in section 22.1.1.

example: output: current output
 output range: 4...20 mA
 Zero-Scale Val.: 0 m³/h
 Full-Scale Val.: 300 m³/h
 volumetric flow rate = 0 m³/h, corresponds to 4 mA
 volumetric flow rate = 300 m³/h, corresponds to 20 mA

22.3.2 Function Test

The function of the installed output can now be tested. Connect a multimeter to the installed output.

```
I1: Test output ?
no      >YES<
```

Select **yes** to test the output. Press ENTER.

```
I1: Test value =
150.00  m3/h
```

Enter a test value for the selected physical quantity. If the multimeter displays the corresponding current value, the output functions correctly. Press ENTER.

```
I1: Test output ?
no      >YES<
```

Select **yes** to repeat the test. Press ENTER.

example: output: current output
 output range: 4...20 mA
 Zero-Scale Val.: 0 m³/h
 Full-Scale Val.: 300 m³/h
 Test value = 150 m³/h (center of the measuring range, corresponds to 12 mA)
 If the multimeter displays 12 mA, the current output functions correctly.

22.4 Configuration of an Output Using the Adapter for the Active Current Input

Installation of the output

```
SYSTEM settings↓
Proc. outputs
```

Select Special Funct.\SYSTEM settings\
Proc. outputs.
Press ENTER.

```
Install Output ↓
Current I1 (✓)
```

Select the output Current I1. Press ENTER.
A tick (✓) after a list item indicates that this output has already been installed.

```
I1 enable
no >YES<
```

This display will be indicated if the output has not been installed yet.
Select yes. Press ENTER.

```
I1 Source chan.↓
Channel A:
```

Select in the scroll list the measuring channel to be assigned as source channel to the output. Press ENTER.

```
Source item ↓
Miscellaneous
```

Select in the scroll list Miscellaneous.
Press ENTER.

```
Miscellaneous ↓
Signal
```

Select in the scroll list Signal.
Press ENTER.

```
I1:Output range↓
other range
```

When configuring an analog output, the output range will be defined now. Select other range to enter the output range manually.

```
I1 Output MIN ↓
4.0 mA
```

Enter 4 mA. Press ENTER.

```
I1 Output MAX ↓
22.0 mA
```

Enter 22 mA. Press ENTER.

```
Error-value ↓
Other value...
```

Select a list item Other value for the error output.
Press ENTER.

```
Error-value
22.0 mA
```

Enter the error value 22 mA.
Press ENTER.

Measuring range of the analog outputs

After an analog output has been activated in the program branch `Output Options`, the measuring range of the source item has to be entered.

```
Meas.Values
>ABSOLUT<  sign
```

Select `absolut`.

```
Zero-Scale Val.
0.00  %
```

Enter the value `0.00`. The unit of measurement of the source item will be displayed.

`Zero-Scale Val.` is the measured value assigned to the lower limit of the output range.

```
Full-Scale Val.
0.01  %
```

Enter the highest expected measured value.

`Full-Scale Val.` is the measured value assigned to the upper limit of the output range.

Note!

If the output `P1` is not used, the outputs `P1` and `P2` should be deactivated in order to reduce the battery life.

22.5 Configuration of a Frequency Output as a Pulse Output

A A frequency output sends a signal with a frequency that depends on the volumetric flow rate. The frequency output can be configured in such way that the source item can be totalized by using each period of the output signal as the increment.

22.5.1 Installation of a Frequency Output (optional)

```
Install Output ↑
Frequency F1
```

Select `Frequency F1` in `Special Funct.\SYSTEM settings\Proc. outputs`. Press `ENTER`.

```
F1 enable
no  >YES<
```

Select `yes` if the output has not been installed. Press `ENTER`.

or

```
F1 disable
>NO<  yes
```

Select `no` if the output has already been installed. Press `ENTER`.

```
F1 Source chan.↑
Channel A:
```

Select in the scroll list the measuring channel to be assigned as source channel to the output. Press `ENTER`.

```
F1 Source item ↓
Measuring value
```

Select in the scroll list `Measuring value` (but not `Impuls!`). Press ENTER.

```
Setup as pulse ?
no >YES<
```

If `Measuring value` is selected and the source item can be totaled, a request will be indicated whether the frequency output is to be configured as a pulse output. Select `yes`. Press ENTER.

```
F1 Output MAX
1.0 kHz
```

Enter the upper limit of the frequency. Press ENTER.

The lower limit of the frequency and the error value will be set automatically to 0.5 Hz.

22.5.2 Activation of the Output

```
Output Options ↓
for Channel A:
```

In the program branch `Output Options`, select the channel for which the input is to be activated. Press ENTER.

This display will not be indicated if the transmitter has only one measuring channel.

```
Frequency Output
F1: no >YES<
```

Select `yes` to activate the output. Press ENTER.

```
Pulses per unit:
1000 /m3
```

Enter the number of pulses that is to be assigned to the unit of measurement of the totalizer. Press ENTER.

Example: 1000 pulses correspond to 1 m³ of the totaled fluid.

```
INFO: max flow=
3600.0 m3/h
```

The max. flow depending on the upper limit of the frequency and pulse value is indicated. Press ENTER.

22.6 Activation of a Binary Output as a Pulse Output

A pulse output is an integrating output which emits a pulse when the volume or the mass of the fluid which has passed the measuring point reaches a given value (`Pulse Value`). The integrated quantity is the selected physical quantity. Integration is restarted as soon as a pulse is emitted.

Note!	The menu item <code>Pulse Output</code> will only be indicated in the program branch <code>Output Options</code> if a pulse output has been installed.
--------------	--

```
Output Options ↓
for Channel  A:
```

Select in the program branch `Output Options` the channel for which a pulse output is to be activated. Press `ENTER`. This display will not be indicated if the transmitter has only one measuring channel.

```
Pulse Output
B1: no      >YES<
```

Select `yes` to activate the output. Press `ENTER`.

```
Pulse Output
NO COUNTING  !
```

This error message will be displayed if the flow velocity is selected as the physical quantity.

The use of the pulse output is not possible in this case because integrating the flow velocity does not result in a reasonable value.

```
Pulse Value
0.01      m3
```

Enter the pulse value. The unit of measurement will be displayed according to the actual physical quantity.

When the counted physical quantity reaches the introduced pulse value, a pulse will be transmitted.

```
Pulse Width
100      ms
```

Enter the pulse width.

The range of possible pulse widths depends on the specification of the instrument (e.g., counter, PLC) that is to be connected to the output.

The max. flow that the pulse output can work with will be displayed now. This value is calculated on the basis of the entered pulse value and pulse width.

If the flow exceeds this value, the pulse output does not work correctly. In this case, the pulse value and the pulse width have to be adapted to the flow conditions. Press `ENTER`.

22.7 Activation of a Binary Output as an Alarm Output

Note!	The menu item <code>Alarm Output</code> will only be displayed in the program branch <code>Output Options</code> if an alarm output has been installed.
--------------	---

```
Output Options ↓
for Channel  A:
```

Select in the program branch `Output Options` the channel for which an alarm output is to be activated. Press `ENTER` until the menu item `Alarm Output` is displayed.

This display will not be indicated if the transmitter has only one measuring channel.

```
Alarm Output
no          >YES<
```

Select **yes** to activate the alarm output. Press **ENTER**.

Max. 3 alarm outputs R1, R2, R3 per channel operating independently of each other can be configured. The alarm outputs can be used to output information on the current measurement or to start and stop pumps, motors, etc.

22.7.1 Alarm Properties

The switching condition, the holding behavior and the switching function of an alarm output can be defined.

```
R1=FUNC<typ mode
Function:    MAX
```

Three scroll lists will be displayed:

- **func**: switching condition
- **typ**: holding behavior
- **mode**: switching function

Press key **4** and **6** to select a scroll list in the upper line. Press key **8** and **2** to select a list item in the lower line.

Press **ENTER** to store the settings.

Tab. 22.4: Alarm properties

alarm property	setting	description
func (switching condition)	MAX	The alarm will switch if the measured value exceeds the upper limit.
	MIN	The alarm will switch if the measured value falls below the lower limit.
	+→- -→+	The alarm will switch if the flow direction changes (sign change of measured value).
	QUANT.	The alarm will switch if totalizing is activated and the totalizer reaches the limit.
	ERROR	The alarm will switch if a measurement is not possible.
	OFF	The alarm is switched off.

Tab. 22.4: Alarm properties

alarm property	setting	description
typ (holding behavior)	NON-HOLD	If the switching condition is no longer true, the alarm will return to the idle state after approx. 1 s.
	HOLD	The alarm remains activated even if the switching condition is no longer true.
mode (switching function)	NO Cont.	The alarm is energized if the switching condition is true and de-energized if idle.
	NC Cont.	The alarm is de-energized if the switching condition is true and energized if idle.

Note! If no measurement is made, all alarms will be de-energized, independently of the programmed switching function.

22.7.2 Setting the Limits

If the switching condition **MAX** or **MIN** is selected in the scroll list *func*, the limit of the output will have to be defined:

```
R1 Input:      ↑
Volume flow
```

Select in the scroll list *Input* the physical quantity to be used for the comparison. The following list items are available:

- selected physical quantity
- signal amplitude
- sound speed of the fluid

Press ENTER.

```
High Limit:
-10.00    m3/h
```

switching condition: **MAX**

Enter the upper limit. Press ENTER.

The alarm will switch if the measured value exceeds the limit.

```
Low Limit:
-10.00    m3/h
```

switching condition: **MIN**

Enter the lower limit. Press ENTER.

The alarm will switch if the measured value falls below the limit.

example 1: High Limit:: -10 m³/h
 volumetric flow rate = -9.9 m³/h
 the limit is exceeded, the alarm switches
 volumetric flow rate = -11 m³/h
 the limit is not exceeded, the alarm does not switch

example 2: Low Limit:: -10 m³/h
 volumetric flow rate = -11 m³/h
 the measured value is below the limit, the alarm switches
 volumetric flow rate = -9.9 m³/h
 the measured value is not below the limit, the alarm does not switch

If the switching condition `QUANT.` is selected in the scroll list `func`, the limit of the output will have to be defined:

Quantity Limit:
 1.00 m3

switching condition: `QUANT.`

Enter the limit of the totalizer. Press ENTER.

The alarm will switch if the measured value reaches the limit.

A positive limit will be compared to the totalizer value for the positive flow direction.

A negative limit will be compared to the totalizer value for the negative flow direction.

The comparison will also take place if the totalizer of the other flow direction is displayed.

Note!

The unit of measurement of the limit corresponds to the unit of measurement of the selected physical quantity.

If the unit of measurement of the physical quantity is changed, the limit has to be converted and entered again.

example 1: physical quantity: volumetric flow rate in m³/h
 Quantity Limit:: 1 m³

example 2: physical quantity: volumetric flow rate in m³/h
 Low Limit:: 60 m³/h
 The unit of measurement of the physical quantity is changed to m³/min. The new limit to be entered is 1 m³/min.

22.7.3 Defining the Hysteresis

A hysteresis can be defined for the alarm output R1 to prevent a constant triggering of the alarm due to small fluctuations of the measured values around the limit.

The hysteresis is a symmetrical range around the limit. The alarm will be activated if the measured values exceed the upper limit and deactivated if the measured values fall below the lower limit.

example: High Limit: 30 m³/h
 Hysteresis: 1 m³/h
 The alarm is triggered for measured values > 30.5 m³/h and deactivated for measured values < 29.5 m³/h.

R1 Hysteresis: 1.00 m ³ /h
--

switching condition: MIN or MAX

Enter the value for Hysteresis.

or

Enter 0 (zero) to work without a hysteresis.

Press ENTER.

22.8 Behavior of the Alarm Outputs

22.8.1 Apparent Switching Delay

The measured values and the totalizer values will be displayed rounded to 2 decimal places. The limits, however, will be compared to the non-rounded measured values. This might cause an apparent switching delay when the measured value changes marginally (less than 2 decimal places). In this case the switching accuracy of the output is higher than the accuracy of the display.

22.8.2 Reset and Initialization of the Alarms

After an initialization of the transmitter all alarm outputs will be configured as follows:

Tab. 22.5: Alarm state after an initialization

func	OFF
typ	NON-HOLD
mode	NO Cont.
Limit	0.00

Press three times key C during measurement to set all alarm outputs to the idle state. Alarm outputs whose switching condition is still met will be activated again after 1 s. This function is used to reset alarm outputs of the type HOLD if the switching condition is no longer met.

By pressing key BRK, the measurement is stopped and the main menu is selected. All alarm outputs will be de-energized, independently of the programmed idle state.

22.8.3 Alarm Outputs during Transducer Positioning

At the beginning of the transducer positioning (bar graph display), all alarm outputs switch back to the programmed idle state.

If the bar graph is selected during measurement, all alarm outputs will switch back to the programmed idle state.

An alarm output of the type `HOLD` that has been activated during the previous measurement will remain in the idle state after the transducer positioning if the switching condition is no longer met.

Switching of the alarms into the idle state will not be displayed.

22.8.4 Alarm Outputs during Measurement

An alarm output with switching condition `MAX` or `MIN` will be updated max. once per second to avoid humming (i.e. fluctuation of the measured values around the value of the switching condition).

An alarm output of the type `NON-HOLD` will be activated if the switching condition is met. It will be deactivated if the switching condition is no longer met. The alarm will remain activated min. 1 s even if the switching condition is met for a shorter period of time.

Alarm outputs with the switching condition `QUANT.` will be activated if the limit is reached.

Alarm outputs with the switching condition `ERROR` will only be activated after several unsuccessful measuring attempts. Therefore, typical short-term disturbances of the measurement (e.g., switching on of a pump) will not activate the alarm.

Alarm outputs with the switching condition `+→- -→+` and of the type `NON-HOLD` will be activated with each change of the flow direction for approx. 1 s (see Fig. 22.2).

Alarm outputs with the switching condition `+→- -→+` and of the type `HOLD` will be activated after the first change of the flow direction. They can be switched back by pressing key C three times (see Fig. 22.2).

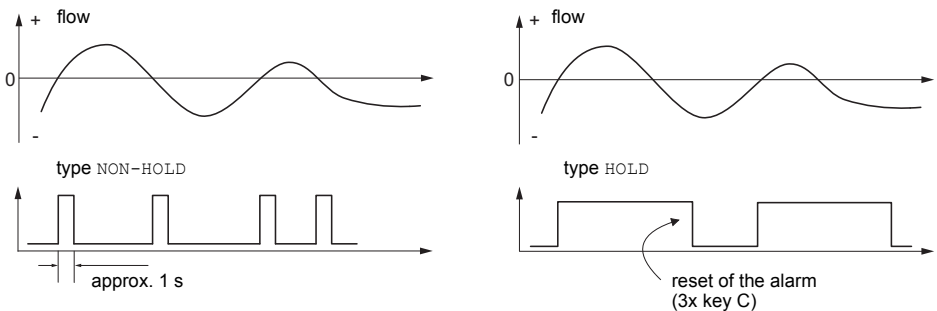

Fig. 22.2: Behavior of a relay when the flow direction changes

When adjusting measurement conditions e.g. a substantial increase of the fluid temperature, the alarm will not be switched. Alarm outputs with the switching condition `OFF` will be set automatically to the switching function `NO Cont..`

22.8.5 Alarm State Indication

Note! There is no visual or acoustic indication of alarm output switching.

The alarm state can be displayed during the measurement. This function is activated in Special Funct.\SYSTEM settings\Dialogs/Menus.





SHOW RELAIS STAT
off >ON<

Select the menu item SHOW RELAIS STAT. Select on to activate the alarm state indication.

















Press key 9 to scroll through the upper line until the alarm state is displayed.

RX = , with being a pictogram as shown in Tab. 22.6.

example:

R1 =    

Tab. 22.6: Pictograms for the alarm state indication

No	func (switching condition)	typ (holding behavior)	mode (switching function)	current state
R				
1	 OFF	 NON-HOLD	 NO Cont.	 closed
2	 MAX	 HOLD	 NC Cont.	 open
3	 MIN			
	 +→- -→+			
	 QUANT.			
	 ERROR			

22.9 Deactivation of the Outputs

If the programmed outputs are no longer required, they can be deactivated. The configuration of a deactivated output is stored and will be available if the output is activated again.

```
Alarm Output
>NO<          yes
```

Select no in Output Options\Alarm Output to deactivate an output.
Press ENTER.

23 Troubleshooting

If any problem appears which cannot be solved with the help of this user manual, contact our sales office and give a precise description of the problem. Specify the type, the serial number and the firmware version of the transmitter.

Calibration

FLUXUS is a very reliable instrument. It is manufactured under strict quality control using modern production techniques. If installed as recommended in an appropriate location, used cautiously and taken care of conscientiously, no troubles should appear. The transmitter has been calibrated at the factory and, usually, a re-calibration of the transmitter will not be necessary.

- the contact surface of the transducers shows visible wear or
- the transducers were used for a prolonged period of time at a high temperature (several months >130 °C for normal transducers or > 200 °C for high temperature transducers).

The transmitter has to be sent to FLEXIM for recalibration under reference conditions.

The display does not work at all or fails regularly

Check the contrast setting of the transmitter (see section 17.4).

Check that the battery is inserted and charged. Connect the power supply. If the power supply is ok, the transducers or an internal component of the transmitter are defective. The transducers and the transmitter have to be sent to FLEXIM for repair.

The message "System Error" is displayed.

Press key BRK to return to the main menu.

If this message is displayed repeatedly, write down the number in the lower line. Track down the situations when the error is displayed. Contact FLEXIM.

The backlight of the display does not work, but all other functions are available.

The backlight is defective. This problem does not affect the other functions of the display. Send the transmitter to FLEXIM for repair.

Date and time are wrong, the measured values are deleted when the transmitter is switched off

The data backup battery has to be replaced. Send the transmitter to FLEXIM.

An output does not work

Make sure that the outputs are configured correctly. Check the function of the output as described in section 22.1.3. If the output is defective, contact FLEXIM.

A measurement is impossible or the measured values substantially differ from the expected values

see section 23.1.

The values of the totalizers are wrong

see section 23.6.

23.1 Problems with the Measurement

A measurement is impossible because no signal is received. A question mark is displayed in the lower line on the right

- Check if the entered parameters are correct, especially the outer pipe diameter, the pipe wall thickness and the sound speed of the fluid. (Typical errors: The circumference or the radius was entered instead of the diameter. The inner pipe diameter was entered instead of the outer pipe diameter.)
- Make sure that the recommended transducer distance was adjusted when mounting the transducers.
- Make sure that an appropriate measuring point is selected (see section 23.2).
- Try to establish better acoustic contact between the pipe and the transducers (see section 23.3).
- Enter a lower value for the number of sound paths. The signal attenuation might be too high due to a high fluid viscosity or deposits on the inner pipe wall (see section 23.4).

The measuring signal is received but no measured values can be obtained

- An exclamation mark "!" in the lower line on the right indicates that the defined upper limit of the flow velocity is exceeded and, therefore, the measured values are marked as invalid. The limit has to be adapted to the measuring conditions or the check has to be deactivated (see section 13.4).
- If no exclamation mark "!" is displayed, a measurement at the selected measuring point is not possible.

Loss of signal during the measurement

- If the pipe had been run empty: Was there no measuring signal afterwards? Contact FLEXIM.
- Wait briefly until acoustic contact is reestablished. The measurement can be interrupted by a temporarily higher proportion of gas bubbles and solids in the fluid.

The measured values substantially differ from the expected values

- Wrong measured values are often caused by wrong parameters. Make sure that the entered parameters are correct for the measuring point.
- If the parameters are correct, see section 23.5 for the description of typical situations in which wrong measured values are obtained.

23.2 Selection of the Measuring Point

- Make sure that the recommended min. distance to any disturbance source is observed (see chapter 5, Tab. 5.2).
- Avoid measuring points with deposit formation in the pipe.
- Avoid measuring points in the vicinity of deformations and defects on the pipe and in the vicinity of welds.
- Measure the temperature at the measuring point and make sure that the transducers are suitable for this temperature.
- Make sure that the outer pipe diameter is within the measuring range of the transducers.
- When measuring on a horizontal pipe, the transducers have to be mounted on the side of the pipes.
- A vertical pipe always has to be filled at the measuring point and the fluid should flow upward.
- No gas bubbles should form (even bubble-free media can form gas bubbles when the fluid expands, e.g., upstream of pumps and downstream of great cross-section enlargements).

23.3 Maximum Acoustic Contact

Observe the instructions in chapter 8.

23.4 Application Specific Problems

The entered sound speed of the fluid is wrong

The entered sound speed is used to calculate the transducer distance and is therefore very important for the transducer positioning. The sound speeds stored in the transmitter only serve as orientation.

The entered pipe roughness is not appropriate

Check the entered value. The state of the pipe should be taken into account.

Measurements on porous pipe materials (e.g., concrete or cast iron) are only possible under certain conditions

Contact FLEXIM.

The pipe lining may cause problems during the measurement if it is not firmly attached to the inner pipe wall or consists of an acoustically absorbing material

Try measuring on a liner free section of the pipe.

Highly viscous media strongly attenuate the ultrasonic signal

Measurements on media with a viscosity $> 1000 \text{ mm}^2/\text{s}$ are only possible under certain conditions.

A higher proportion of gas or solids in the fluid scatter and absorb the ultrasonic signal and therefore attenuate the measuring signal

A measurement is impossible if the value is $\geq 10\%$. If the proportion is high, but $< 10\%$, a measurement is only possible under certain conditions.

The flow is in the transition range between laminar and turbulent flow where flow measurement is difficult

Calculate the Reynolds number of the flow at the measuring point with the program Flux-Flow (free download: www.flexim.com). Contact FLEXIM.

23.5 Large Deviations of the Measured Values

The entered sound speed of the fluid is wrong

A wrong sound speed can result in the ultrasonic signal that is reflected directly on the pipe wall being mistaken for the measuring signal that has passed through the fluid. The flow calculated on the basis of the wrong signal by the transmitter is very small or fluctuates around zero.

There is gas in the pipe

If there is gas in the pipe, the measured flow will always be too high because both the gas volume and the liquid volume are measured.

The defined upper limit of the flow velocity is too low

All measured flow velocities that are greater than the upper limit will be ignored and marked as invalid. All quantities derived from the flow velocity will also be marked as invalid. If several correct measured values are ignored, the totalizer values will be too low.

The entered cut-off flow is too high

All flow velocities below the cut-off flow are set to zero. All derived quantities are also set to zero. The cut-off flow (default 2.5 cm/s) has to be set to a low value to be able to measure at low flow velocities.

The entered pipe roughness is not appropriate**The flow velocity of the fluid is outside the measuring range of the transmitter****The measuring point is not appropriate**

Select another measuring point to check whether the results are better. Because pipes are never rotationally symmetric, the flow profile is affected. Change the transducer position according to the pipe deformation.

23.6 Problems with the Totalizers

The values of the totalizers are too high

See `Special Function\SYSTEM settings\Measuring\Quantity recall`. If this menu item is activated, the values of the totalizer will be stored. The totalizer will continue with this value at the start of the next measurement.

The values of the totalizers are too small

One of the totalizers has reached the upper limit and has to be reset to zero manually.

The sum of the totalizers is not correct

See `Special Function\SYSTEM settings\Measuring\Quantity wrapping`. The sum of both totalizers (throughput) transmitted via an output is not valid after the overflow (wrapping) of one of the totalizers.

23.7 Problems During the Heat Flow Measurement

The measured temperature values differ from the actual values.

The temperature probes are not sufficiently insulated.

On a pipe with a small pipe diameter, the temperature probe is lifted from the pipe surface by the insulation foam.

The measured absolute value of the heat flow is correct but has the opposite sign.

Check the assignment of the supply and return temperature to the temperature inputs (see section 20.2 or 20.3).

The calculated heat flow differs from the actual heat flow although the measured flow and temperature values are correct

Check the heat flow coefficient of the fluid (see section 16.3.4).

23.8 Transmission of Data

The file with the transmitted measuring data contains meaningless strings

The transmission parameters of the transmitter and the transmission program are not identical. Adjust the transmission parameters of the transmitter (see section 14.2.4) and of the program FluxData (see section 14.2.7) or and of the terminal program.

A Menu Structure

		INIT-resistant
Program Branch Parameter		
<pre>>PAR< mea opt sf Parameter</pre>	main menu: selection of the program branch Parameter	
<pre>Parameter ↓ for Channel A:</pre>	selection of a measuring channel (A, B) or of a calculation channel (Y, Z) This display will not be indicated if the transmitter has only one measuring channel.	
<pre>Parameter from:↓ Par.Record 01</pre>	selection of a parameter record This display will only be indicated if at least one parameter record has been defined.	
<pre>Edit Parameters >NO< yes</pre>	selection if the parameters of the parameter record are to be edited	
When a measuring channel is selected (A, B)		
<pre>Outer Diameter 100.0 mm</pre>	input of the outer pipe diameter	
<pre>Pipe Circumfer. 314.2 mm</pre>	input of the pipe circumference This display will only be indicated if Special Funct.\SYSTEM settings\Dialogs/ Menus\Pipe Circumfer. is activated and Outer Diameter = 0 has been entered.	
<pre>Wall Thickness 3.0 mm</pre>	input of the pipe wall thickness range: depends on the connected transducers default: 3 mm	
<pre>Pipe Material ↓ Carbon Steel</pre>	selection of the pipe material	

	INIT-resistant
<div style="border: 1px solid black; padding: 5px; width: fit-content;"> c-Material 3230.0 m/s </div>	input of the sound speed of the pipe material range: 600...6553.5 m/s This display will only be indicated if <code>Other Material</code> is selected.
<div style="border: 1px solid black; padding: 5px; width: fit-content;"> Lining no >YES< </div>	selection whether the pipe is lined
<div style="border: 1px solid black; padding: 5px; width: fit-content;"> Lining ↑ Bitumen </div>	selection of the lining material This display will only be indicated if <code>Lining = yes</code> is selected.
<div style="border: 1px solid black; padding: 5px; width: fit-content;"> c-Material 3200.0 m/s </div>	input of the sound speed of the lining material range: 600...6553.5 m/s This display will only be indicated if <code>Other Material</code> is selected.
<div style="border: 1px solid black; padding: 5px; width: fit-content;"> Liner Thickness 3.0 mm </div>	input of the liner thickness range: 0...50 mm default: 3 mm
<div style="border: 1px solid black; padding: 5px; width: fit-content;"> Roughness 0.4 mm </div>	input of the roughness of the inner pipe wall range: 0...5 mm default: 0.1 mm (for steel as pipe material)
<div style="border: 1px solid black; padding: 5px; width: fit-content;"> Medium ↑ Water </div>	selection of the fluid
<div style="border: 1px solid black; padding: 5px; width: fit-content;"> c-Medium 1500.0 m/s </div>	input of the average sound speed of the fluid range: 500...3500 m/s This display will only be indicated if <code>Other Medium</code> is selected.

	INIT-resistant
<div style="border: 1px solid black; padding: 5px; width: fit-content;"> c-Medium range auto >USER< </div>	selection of the sound speed range auto: The area around the average sound speed is defined by the transmitter. user: The area around the average sound speed has to be entered.
<div style="border: 1px solid black; padding: 5px; width: fit-content;"> c-Medium=1500m/s range +/-150m/s </div>	input of the area around the average sound speed of the fluid This display will only be indicated if user is selected.
<div style="border: 1px solid black; padding: 5px; width: fit-content;"> Kinem.Viscosity 1.00 mm²/s </div>	input of the kinematic viscosity of the fluid range: 0.01...30 000 mm ² /s This display will only be indicated if Other Medium is selected.
<div style="border: 1px solid black; padding: 5px; width: fit-content;"> Density 1.00 g/cm³ </div>	input of the operating density of the fluid range: 0.01...20 g/cm ³ This display will only be indicated if Other Medium is selected.
<div style="border: 1px solid black; padding: 5px; width: fit-content;"> Medium Temperat. 20.0 C </div>	input of the fluid temperature default: 20 °C
<div style="border: 1px solid black; padding: 5px; width: fit-content;"> Fluid pressure 1.00 bar </div>	input of the fluid pressure range: 1...600 bar This display will only be indicated if Special Funct.\SYSTEM settings\Dialogs\Menus\Fluid pressure is activated.
<div style="border: 1px solid black; padding: 5px; width: fit-content;"> Transducer Type↑ Standard </div>	selection of the transducer type This display will only be indicated if no or special transducers are connected.
<p>When a calculation channel is selected (Y, Z) Calculation channels are only available if the transmitter has more than one measuring channel.</p>	
<div style="border: 1px solid black; padding: 5px; width: fit-content;"> Calculation: Y= A - B </div>	display of the current calculation function

	INIT-resistant
<div style="border: 1px solid black; padding: 5px; margin-bottom: 10px;"> <pre>>CH1< funct ch2↓ A - B</pre> </div> <p>selection of the calculation function</p>	
<p>Program Branch Measuring</p>	
<div style="border: 1px solid black; padding: 5px; margin-bottom: 10px;"> <pre>par >MEA< opt sf Measuring</pre> </div> <p>main menu: selection of the program branch Measuring</p>	
<div style="border: 1px solid black; padding: 5px; margin-bottom: 10px;"> <pre>CHANN:>A< B Y Z MEASUR ✓ ✓ - .</pre> </div> <p>activation of the channels This display will not be indicated if the transmitter has only one measuring channel.</p>	
<div style="border: 1px solid black; padding: 5px; margin-bottom: 10px;"> <pre>A:Meas.Point No.: xxx (↑↓←→)</pre> </div> <p>input of the measuring point number This display will only be indicated if Output Options\Store Meas.Data and/or Serial Output are activated.</p>	
<div style="border: 1px solid black; padding: 5px; margin-bottom: 10px;"> <pre>A:PROFILE CORR. >NO< yes</pre> </div> <p>activation/deactivation the flow profile correction This display will only be indicated if Special Funct.\SYSTEM settings\Measuring\Flow Velocity = uncorr. is selected.</p>	
<div style="border: 1px solid black; padding: 5px; margin-bottom: 10px;"> <pre>A: Sound Path 2 NUM</pre> </div> <p>input of the number of sound paths This display will only be indicated if Special Funct.\SYSTEM settings\Dialogs/Menus\Sound Path = USER is selected.</p>	
<div style="border: 1px solid black; padding: 5px; margin-bottom: 10px;"> <pre>Transd. Distance A:54 mm Reflex</pre> </div> <p>display of the transducer distance to be adjusted between the inner edges of the transducers This display will only be indicated if in Special Funct.\SYSTEM settings\Dialogs/Menus\Sound Path = user is selected.</p>	
<div style="border: 1px solid black; padding: 5px;"> <pre>S=■■■■■■■ A:■< >■=54 mm!</pre> </div> <p>bar graph s=, display of the amplitude of the received signal</p>	

	INIT-resistant
<p>Program Branch Output Options</p> <div data-bbox="112 239 397 327" style="border: 1px solid black; padding: 5px; margin-bottom: 10px;"> <pre>par mea >OPT< sf Output Options</pre> </div> <p data-bbox="425 239 935 295">main menu: selection of the program branch Output Options</p> <div data-bbox="112 351 397 438" style="border: 1px solid black; padding: 5px; margin-bottom: 10px;"> <pre>Output Options ↓ for Channel A:</pre> </div> <p data-bbox="425 343 935 399">selection of the channel whose output options are to be defined</p> <div data-bbox="112 462 397 550" style="border: 1px solid black; padding: 5px; margin-bottom: 10px;"> <pre>Physic. Quant. ↓ Volume flow</pre> </div> <p data-bbox="425 454 935 486">selection of the physical quantity</p> <div data-bbox="112 566 397 654" style="border: 1px solid black; padding: 5px; margin-bottom: 10px;"> <pre>Volume in: ↓ m3/h</pre> </div> <p data-bbox="425 558 935 614">selection of the unit of measurement for the physical quantity</p> <div data-bbox="112 678 397 766" style="border: 1px solid black; padding: 5px; margin-bottom: 10px;"> <pre>Temperature T1 no >YES<</pre> </div> <p data-bbox="425 670 935 845">activation of a temperature input This display will only be indicated if the temperature input T1 has been assigned to the channel in Special Funct.\SYSTEM settings\ Proc. inputs\Link temperature.</p> <div data-bbox="112 869 397 957" style="border: 1px solid black; padding: 5px; margin-bottom: 10px;"> <pre>INPUT I1 no >YES<</pre> </div> <p data-bbox="425 861 935 1045">activation of a current input for an external temperature measurement This display will only be indicated if the input I1 has been assigned to the channel in Special Funct.\SYSTEM settings\ Proc. inputs\Link other inp..</p> <div data-bbox="112 1061 397 1149" style="border: 1px solid black; padding: 5px; margin-bottom: 10px;"> <pre>Damping 10 s</pre> </div> <p data-bbox="425 1061 935 1189">input of the duration over which a floating average of the measured values has to be determined range: 1...600 s</p> <div data-bbox="112 1204 397 1292" style="border: 1px solid black; padding: 5px; margin-bottom: 10px;"> <pre>Store Meas.Data no >YES<</pre> </div> <p data-bbox="425 1204 935 1236">activation of the data logger</p> <div data-bbox="112 1316 397 1404" style="border: 1px solid black; padding: 5px;"> <pre>Serial Output no >YES<</pre> </div> <p data-bbox="425 1308 935 1364">activation of the measured values transmission to a PC or a printer via a serial interface</p>	

	INIT-resistant
<div style="border: 1px solid black; padding: 5px; width: fit-content;"> Storage Rate ↓ Once per 10 sec. </div>	<p>selection of the storage rate for storing measured values in the data logger</p> <p>This display will only be indicated if Output Options\Store Meas.Data and/or Serial Output are activated.</p>
<div style="border: 1px solid black; padding: 5px; width: fit-content;"> Storage Rate 1 s </div>	<p>input of the storage rate if Storage Rate = EXTRA is selected</p> <p>range: 1...43 200 s (= 12 h)</p>
<p>Current Loop</p>	
<div style="border: 1px solid black; padding: 5px; width: fit-content;"> Current Loop I1: no >YES< </div>	<p>activation of a current output</p> <p>This display will only be indicated if the current output has been installed in Special Funct.\SYSTEM settings\Proc. outputs.</p>
<div style="border: 1px solid black; padding: 5px; width: fit-content;"> Meas.Values >ABSOLUT< sign </div>	<p>selection whether the sign of the measured values is to be considered for the output</p> <p>This display will only be indicated if Current Loop is activated.</p>
<div style="border: 1px solid black; padding: 5px; width: fit-content;"> Zero-Scale Val. 0.00 m3/h </div>	<p>input of the lowest/highest measured value to be expected for the current output</p> <p>The values are assigned to the lower/upper limit of the output range.</p>
<div style="border: 1px solid black; padding: 5px; width: fit-content;"> Full-Scale Val. 300.00 m3/h </div>	<p>These displays will only be indicated if Current Loop is activated.</p>
<div style="border: 1px solid black; padding: 5px; width: fit-content;"> Error-val. delay 10 s </div>	<p>input of the error value delay, i.e. the time interval after which the error value is transmitted to the output in case no valid measured values are available</p>
	<p>This display will only be indicated if Special Funct.\SYSTEM settings\Dialogs/ Menus\Error-val. delay = EDIT is selected.</p>

		INIT- resistant
Pulse Output		
Pulse Output B1: no >YES<	activation of a pulse output This display will only be indicated if a pulse output has been installed in Special Funct.\SYSTEM settings\Dialogs/ Menus\Proc. outputs.	
Pulse Value 0.01 m3	input of the pulse value (value of the flow totalizer at which a pulse will be emitted) This display will only be indicated if Pulse Output is activated.	
Pulse Width 100 ms	input of the pulse width range: 1 1000 ms This display will only be indicated if Pulse Output is activated.	
Alarm Output		
Alarm Output no >YES<	activation of an alarm output This display will only be indicated if an alarm output has been installed in Special Funct.\SYSTEM settings\Proc. outputs.	
R1=FUNC<typ mode Function: MAX	selection of the switching condition (func), the holding behavior (typ) and the switching function (mode) of the alarm output This display will only be indicated if Alarm Output is activated.	
R1 Input: † Volume flow	selection of the physical quantity to be monitored This display will only be indicated for R1 if Alarm Output is activated.	
High Limit: -10.00 m3/h	input of the upper limit of the physical quantity to be monitored This display will only be indicated if Alarm Output is activated and MAX is selected as the switching condition.	

	INIT-resistant
<div style="border: 1px solid black; padding: 5px; width: fit-content;"> Low Limit: -10.00 m3/h </div>	<p>input of the lower limit of the physical quantity to be monitored</p> <p>This display will only be indicated if Alarm Output is activated and MIN is selected as the switching condition.</p>
<div style="border: 1px solid black; padding: 5px; width: fit-content;"> Quantity Limit: 1.00 m3 </div>	<p>input of the limit for the totalizer of the physical quantity to be monitored</p> <p>This display will only be indicated if Alarm Output is activated and QUANT. is selected as the switching condition.</p>
<div style="border: 1px solid black; padding: 5px; width: fit-content;"> R1 Hysteresis: 1.00 m3/h </div>	<p>input of the hysteresis for the lower or upper limit</p> <p>This display will only be indicated if Alarm Output is activated and MIN or MAX has been selected as the switching condition.</p>
<p>Program Branch Special Funct.</p>	
<div style="border: 1px solid black; padding: 5px; width: fit-content;"> par mea opt >SF< Special Funct. </div>	<p>main menu: selection of the program branch Special Funct.</p>
<p>SYSTEM settings</p>	
<div style="border: 1px solid black; padding: 5px; width: fit-content;"> Special Funct. ↓ SYSTEM settings </div>	<p>selection of Special Funct.\SYSTEM settings</p>
<p>SYSTEM settings\Set Clock</p>	
<div style="border: 1px solid black; padding: 5px; width: fit-content;"> SYSTEM settings↓ Set Clock </div>	<p>selection of the displays for the input of the date and the time</p>
<p>SYSTEM settings\Libraries</p>	
<div style="border: 1px solid black; padding: 5px; width: fit-content;"> SYSTEM settings↓ Libraries </div>	<p>selection of the displays for the management of the material and fluid scroll lists</p>
<p>SYSTEM settings\Libraries\Material list</p>	
<div style="border: 1px solid black; padding: 5px; width: fit-content;"> Libraries ↑ Material list </div>	<p>selection of the displays for the arrangement of the material scroll list (pipe and lining materials)</p>

	INIT-resistant
<p>SYSTEM settings\Libraries\Medium list</p> <div style="border: 1px solid black; padding: 5px; margin-bottom: 10px;"> <p>Libraries ↓ Medium list</p> </div> <p>selection of the displays for the arrangement of the fluid scroll list</p>	
<p>SYSTEM settings\Libraries\Format USER-AREA</p> <div style="border: 1px solid black; padding: 5px; margin-bottom: 10px;"> <p>Libraries ↓ Format USER-AREA</p> </div> <p>selection of the displays for the partitioning of the coefficient memory for the storing of user defined material and fluid parameters</p>	
<div style="border: 1px solid black; padding: 5px; margin-bottom: 10px;"> <p>Format USER-AREA Materials: 03</p> </div> <p>input of the number of user defined materials</p>	
<div style="border: 1px solid black; padding: 5px; margin-bottom: 10px;"> <p>Format USER-AREA Media: 03</p> </div> <p>input of the number of user defined fluids</p>	
<div style="border: 1px solid black; padding: 5px; margin-bottom: 10px;"> <p>Format USER-AREA Heat-Coeffs: 00</p> </div> <p>input of the number of user defined data sets for the heat coefficients</p>	
<div style="border: 1px solid black; padding: 5px; margin-bottom: 10px;"> <p>Format USER-AREA Steam-Coeffs: 00</p> </div> <p>input of the number of user defined data sets for the steam coefficients</p>	
<div style="border: 1px solid black; padding: 5px; margin-bottom: 10px;"> <p>USER AREA: 52% used</p> </div> <p>display of the occupancy of the coefficient memory</p>	
<div style="border: 1px solid black; padding: 5px; margin-bottom: 10px;"> <p>Format NOW? no >YES<</p> </div> <p>confirmation of the selected partition</p>	
<div style="border: 1px solid black; padding: 5px; margin-bottom: 10px;"> <p>FORMATTING ... ■■■■■■■ ...</p> </div> <p>the coefficient memory is being partitioned</p>	
<p>SYSTEM settings\Libraries\Extended Library</p> <div style="border: 1px solid black; padding: 5px;"> <p>Libraries ↓ Extended Library</p> </div> <p>selection of the displays for the activation of the extended library</p>	

		INIT-resistant
<div style="border: 1px solid black; padding: 2px; width: fit-content;"> Extended Library off >ON< </div>	activation of the extended library	x
SYSTEM settings\Dialogs/Menus		
<div style="border: 1px solid black; padding: 2px; width: fit-content;"> SYSTEM settings↓ Dialogs/Menus </div>	selection of the displays for the activation/de-activation or setting of the menu items in the other program branches	
<div style="border: 1px solid black; padding: 2px; width: fit-content;"> Pipe Circumfer. off >ON< </div>	activation of the menu item for the input of the pipe circumference in the program branch Parameter	x
<div style="border: 1px solid black; padding: 2px; width: fit-content;"> Fluid pressure off >ON< </div>	activation of the menu item for the input of the fluid pressure in the program branch Parameter	x
<div style="border: 1px solid black; padding: 2px; width: fit-content;"> Meas.Point No.: (1234) >(↑↓← →)< </div>	selection of the input mode for the measuring point number in the program branch Measuring: (1234): digits, point, hyphen (↑↓← →): ASCII editor	x
<div style="border: 1px solid black; padding: 2px; width: fit-content;"> Sound Path auto >USER< </div>	setting of the display for the input of the sound path in the program branch Measuring: • user: a value for the number of sound paths will be recommended. This value can be changed. • auto: Selection between reflection arrangement or diagonal arrangement. recommended setting: user	x
<div style="border: 1px solid black; padding: 2px; width: fit-content;"> Transd. Distance auto >USER< </div>	setting for the display for the input of the transducer distance in the program branch Measuring: • user: Only the entered transducer distance will be displayed if the recommended and the entered transducer distances are identical. • auto: Only the recommended transducer distance will be displayed. recommended setting: user	x

		INIT-resistant
<div style="border: 1px solid black; padding: 5px; width: fit-content;"> Steam in inlet off >ON< </div>	activation of the menu item for the input of the supply pressure in the program branch <code>Parameter</code> for a heat flow measurement in a fluid that can be a liquid or a gas in the supply line	x
<div style="border: 1px solid black; padding: 5px; width: fit-content;"> Tx Corr.Offset off >ON< </div>	activation of the menu item for the input of a correction value (offset) for each temperature input in the program branch <code>Measuring</code>	x
<div style="border: 1px solid black; padding: 5px; width: fit-content;"> Error-val. delay damping >EDIT< </div>	selection of the error value delay <ul style="list-style-type: none"> • damping: The damping factor will be used. • edit: The menu item for the input of the error value delay in the program branch <code>Output Options</code> will be activated. 	x
<div style="border: 1px solid black; padding: 5px; width: fit-content;"> SHOW RELAIS STAT off >ON< </div>	activation of the display of the alarm state during the measurement	x
<div style="border: 1px solid black; padding: 5px; width: fit-content;"> Length unit >[mm]< [inch] </div>	selection of the unit of measurement for the length	x
<div style="border: 1px solid black; padding: 5px; width: fit-content;"> Temperature >[°C]< [°F] </div>	selection of the unit of measurement for the temperature	x
<div style="border: 1px solid black; padding: 5px; width: fit-content;"> Pressure absolut off >ON< </div>	selection whether the absolute pressure p_a or relative pressure p_g is to be used	x
<div style="border: 1px solid black; padding: 5px; width: fit-content;"> Pressure >[bar]< [psi] </div>	selection of the unit of measurement for the pressure	x
<div style="border: 1px solid black; padding: 5px; width: fit-content;"> Density [lb/ft3] no >YES< </div>	selection if <code>lb/ft3</code> is to be used as unit of measurement for the density	x
<div style="border: 1px solid black; padding: 5px; width: fit-content;"> Density unit g/cm3 >kg/m3< </div>	selection of the unit of measurement for the density This display will only be indicated if <code>lb/ft³</code> has not been selected as the unit of measurement for the density.	x

		INIT-resistant
<div style="border: 1px solid black; padding: 5px; margin-bottom: 10px;"> Viscosity unit mm²/s >cSt< </div>	selection of the unit of measurement for the kinematic viscosity	x
SYSTEM settings\Proc. inputs		
<div style="border: 1px solid black; padding: 5px; margin-bottom: 10px;"> SYSTEM settings↓ Proc. inputs </div>	selection of the displays for the setting of the inputs of the transmitter	
<div style="border: 1px solid black; padding: 5px; margin-bottom: 10px;"> Proc. inputs ↓ Link temperature </div>	assignment of temperature inputs and other inputs to the measuring channels	
<div style="border: 1px solid black; padding: 5px; margin-bottom: 10px;"> A:Thermal energy >HEAT< chill </div>	selection of the application during the heat flow measurement heat: heating application chill: cooling application This display will only be indicated if the BTU-Modbus is activated.	x
<div style="border: 1px solid black; padding: 5px; margin-bottom: 10px;"> Transd. Location >RETURN< supply </div>	selection of the point where the transducers are mounted return: The flow transducers are mounted on the return line. supply: The flow transducers are mounted on the supply line. This display will only be indicated if the BTU-Modbus is activated.	x
<div style="border: 1px solid black; padding: 5px; margin-bottom: 10px;"> Thermal energy >ABSOLUTE< sign </div>	selection if the sign of the measured value of the heat flow is to be considered This display will only be indicated if the BTU-Modbus is activated.	x
<div style="border: 1px solid black; padding: 5px; margin-bottom: 10px;"> A:T-Supply ↓ Input T1 </div>	selection of the temperature input to be assigned to the supply temperature This display will only be indicated if the BTU-Modbus is activated.	x
<div style="border: 1px solid black; padding: 5px; margin-bottom: 10px;"> A:T-Return ↓ Input T2 </div>	selection of the temperature input to be assigned to the return temperature This display will only be indicated if the BTU-Modbus is activated.	x

		INIT-resistant
SYSTEM settings\Measuring		
<code>SYSTEM settings↓ Measuring</code>	selection of the displays for the settings of the measurement	
<code>Enable NoiseTrek off >ON<</code>	enabling the NoiseTrek mode	x
<code>Auto NoiseTrek ? no >YES<</code>	selection whether the toggling between the TransitTime mode and the NoiseTrek mode is to be carried out manually or automatically This display will only be indicated if the NoiseTrek mode is enabled.	x
<code>TT-Failed After →NoiseTrek 40s</code>	input of the time after which the transmitter has to toggle to the NoiseTrek mode if there are no valid measured values in the TransitTime mode range: 0...9999 s 0: without toggling to the NoiseTrek mode This display will only be indicated if the automatic toggling between the TransitTime mode and NoiseTrek mode is activated.	x
<code>NT-Failed After →TransTime 60s</code>	input of the time after which the transmitter toggles to the TransitTime mode if there are no valid measured values in the NoiseTrek mode range: 0...9999 s 0: without toggling to the TransitTime mode This display will only be indicated if the automatic toggling between the TransitTime mode and NoiseTrek mode is activated.	x

	INIT-resistant
<div style="border: 1px solid black; padding: 5px; margin-bottom: 10px;"> NT-Ok, but Each check TT 300s </div>	x input of the time after which the transmitter has to toggle to the TransitTime mode range: 0...9999 s 0: without toggling to the TransitTime mode This display will only be indicated if the automatic toggling between the TransitTime mode and NoiseTrek mode is activated.
<div style="border: 1px solid black; padding: 5px; margin-bottom: 10px;"> Keep TT For checking 5s </div>	x input of the time after which the transmitter has to toggle to the NoiseTrek mode if there are no valid measured values in the TransitTime mode range: 0...9999 s This display will only be indicated if the automatic toggling between the TransitTime mode and NoiseTrek mode is activated.
<div style="border: 1px solid black; padding: 5px; margin-bottom: 10px;"> Compare c-fluid no >YES< </div>	x activation of the display for the difference between the measured and the expected sound speed of a selected reference fluid during the measurement
<div style="border: 1px solid black; padding: 5px; margin-bottom: 10px;"> Flow Velocity normal >UNCORR.< </div>	x selection whether the flow velocity is displayed and transmitted with or without profile correction
<div style="border: 1px solid black; padding: 5px; margin-bottom: 10px;"> Velocity limit 0.0 m/s </div>	x input of an upper limit of the flow velocity range: 0.1...25.5 m/s 0 m/s: no detection for outliers All measured values that are greater than the limit will be marked as outliers.
<div style="border: 1px solid black; padding: 5px;"> Cut-off Flow absolut >SIGN< </div>	x selection of the input of a lower limit for the flow velocity: <ul style="list-style-type: none"> • absolut: independent of the flow direction • sign: dependent on the flow direction

	INIT-resistant
<div style="border: 1px solid black; padding: 5px; width: fit-content;"> Cut-off Flow factory >USER< </div>	activation of the input of a lower limit of the flow velocity: • factory: the default limit of 2.5 cm/s will be used • user: input of a limit
<div style="border: 1px solid black; padding: 5px; width: fit-content;"> +Cut-off Flow 2.5 cm/s </div>	input of the cut-off flow for positive measured values range: 0...12.7 cm/s (0.127 m/s) default: 2.5 cm/s (0.025 m/s) This display will only be indicated if Cut-off Flow = sign and Cut-off Flow = user is selected.
<div style="border: 1px solid black; padding: 5px; width: fit-content;"> -Cut-off Flow -2.5 cm/s </div>	input of the cut-off flow for negative measured values range: -12.7...0 cm/s default: -2.5 cm/s This display will only be indicated if Cut-off Flow = sign and Cut-off Flow = user is selected.
<div style="border: 1px solid black; padding: 5px; width: fit-content;"> Cut-off Flow 2.5 cm/s </div>	input of the cut-off flow for the absolute value of the measured values range: 0...12.7 cm/s default: 2.5 cm/s This display will only be indicated if Cut-off Flow = absolut and Cut-off Flow = user is selected.
<div style="border: 1px solid black; padding: 5px; width: fit-content;"> A: Gain threshold Fail if > 90 dB </div>	input of the max. signal amplification range: 0...255 0: no limit of the signal amplification This display will only be indicated if the SuperUser mode is activated.
<div style="border: 1px solid black; padding: 5px; width: fit-content;"> A: Bad soundspeed thresh. 2007 m/s </div>	input of the fixed upper limit of the sound speed range: 0...3 000 m/s 0: the default limit of 1 848 m/s will be used This display will only be indicated if the SuperUser mode is activated.

	INIT-resistant	
<div style="border: 1px solid black; padding: 5px; width: fit-content;"> A: Bad soundspeed offset: +321 m/s </div>	input of the offset range: 0...900 m/s 0: the default limit of 300 m/s will be used This display will only be indicated if the Super-User mode is activated.	x
<div style="border: 1px solid black; padding: 5px; width: fit-content;"> Heat Quantity >[J]< [Wh] </div>	selection of the unit of measurement for the heat quantity	x
<div style="border: 1px solid black; padding: 5px; width: fit-content;"> heat+flow quant. off >ON< </div>	activation of the transmission and storing of the heat quantity totalizer values during the heat flow measurement	x
<div style="border: 1px solid black; padding: 5px; width: fit-content;"> Quant. wrapping off >ON< </div>	activation of the overflow of the flow totalizers	x
<div style="border: 1px solid black; padding: 5px; width: fit-content;"> Quantity recall off >ON< </div>	activation of the taking-over of the totalizer values after the measurement restart	x
<div style="border: 1px solid black; padding: 5px; width: fit-content;"> Do not total. if no meas.> 0 s </div>	input of a time interval after which the transmitter has to detect a long measurement failure if there are no valid measured values 0: the default value of 30 s is used This display will only be indicated if the Super-User mode is activated.	x
<div style="border: 1px solid black; padding: 5px; width: fit-content;"> Total digits ↑ Automatic </div>	input of the number of decimal places of the totalizers Automatic: dynamic adjustment Fixed to x digit: 0...4 decimal places This display will only be indicated if the Super-User mode is activated.	x
<div style="border: 1px solid black; padding: 5px; width: fit-content;"> Thermal low cut off >ON< </div>	activation of the temperature-based cut-off flow of the heat flow This display will only be indicated if the Super-User mode is activated.	x



	INIT-resistant
<div style="border: 1px solid black; padding: 5px; margin-bottom: 10px;"> Thermal flow ->0 if dT < 0.0 C </div>	input of the limit of the temperature difference All temperature differences between the supply and return line that are lower than this value will be set to zero. range: 0...5.0 °C 0: no temperature-based heat flow cut-cff This display will only be indicated if the Super-User mode is activated and Thermal low cut = on is selcted.
<div style="border: 1px solid black; padding: 5px; margin-bottom: 10px;"> 3xC clear totals off >ON< </div>	activation of the manual reset of the totalizers This display will only be indicated if the Super-User mode is activated.
<div style="border: 1px solid black; padding: 5px; margin-bottom: 10px;"> ShowΣQ off >ON< </div>	activation of the display of the totalizer sum This display will only be indicated if the Super-User mode is activated.
<div style="border: 1px solid black; padding: 5px; margin-bottom: 10px;"> Keep display val off >ON< </div>	activation of the display of the last valid measured value This display will only be indicated if the Super-User mode is activated.
<div style="border: 1px solid black; padding: 5px; margin-bottom: 10px;"> Turbulence mode off >ON< </div>	activation of the turbulence mode
<p>Special Funct.\SYSTEM settings\Measuring\Calibration</p>	
<div style="border: 1px solid black; padding: 5px; margin-bottom: 10px;"> Calibrat. data ↓ for Channel A: </div>	selection of the measuring channel whose flow parameters are to be defined This display will only be indicated if the Super-User mode is activated.
<div style="border: 1px solid black; padding: 5px;"> A:Profile bounds factory >USER< </div>	determination of the profile bounds factory: the default profile bounds will be used user: the profile bounds can be defined This display will only be indicated if the Super-User mode is activated.

	INIT-resistant
<div style="border: 1px solid black; padding: 5px; width: fit-content;"> Laminar flow ifR*< 0 </div>	<p>input of the max Reynolds number at which the flow is laminar</p> <p>range: 0...25 500 (rounded to hundreds) 0: the default limit of 1 000 will be used</p> <p>This display will only be indicated if the Super-User mode is activated and Profile bounds = user is selected.</p>
<div style="border: 1px solid black; padding: 5px; width: fit-content;"> Turbulent flow if R*> 0 </div>	<p>input of the min. Reynolds number at which the flow is turbulent</p> <p>range: 0...25 500 (rounded to hundreds) 0: the default limit of 3 000 will be used</p> <p>This display will only be indicated if the Super-User mode is activated and Profile bounds = user is selected.</p>
<div style="border: 1px solid black; padding: 5px; width: fit-content;"> A:Calibration ? >OFF< on </div>	<p>request if an additional correction of the flow velocity is to be defined</p> <p>on: the correction data can be defined off: without correction of the flow velocity</p> <p>This display will only be indicated if the Super-User mode is activated.</p>
<div style="border: 1px solid black; padding: 5px; width: fit-content;"> A:Slope= 1.000 </div>	<p>input of the slope for the correction formula</p> <p>range: -2.000...+2.000 0.0: without correction</p> <p>This display will only be indicated if the Super-User mode is activated and Calibration = on is selected.</p>
<div style="border: 1px solid black; padding: 5px; width: fit-content;"> A:Offset= 0.0 cm/s </div>	<p>input of the offset</p> <p>range: -12.7...+12.7 cm/s 0: without offset</p> <p>This display will only be indicated if the Super-User mode is activated and Calibration = on is selected.</p>
<p>SYSTEM settings\Proc. outputs</p>	
<div style="border: 1px solid black; padding: 5px; width: fit-content;"> SYSTEM settings↓ Proc. outputs </div>	<p>selection of the displays for the setting of the outputs of the transmitter</p>

	INIT-resistant
<div style="border: 1px solid black; padding: 5px; margin-bottom: 10px;"> Install Output ↓ Current I1 </div>	
SYSTEM settings\Storing	
<div style="border: 1px solid black; padding: 5px; margin-bottom: 10px;"> SYSTEM settings↓ Storing </div>	
<div style="border: 1px solid black; padding: 5px; margin-bottom: 10px;"> Ringbuffer off >ON< </div>	x
<div style="border: 1px solid black; padding: 5px; margin-bottom: 10px;"> Storage mode sample >AVERAGE< </div>	x
<div style="border: 1px solid black; padding: 5px; margin-bottom: 10px;"> Quantity Storage one >BOTH< </div>	x
<div style="border: 1px solid black; padding: 5px; margin-bottom: 10px;"> Store Amplitude off >ON< </div>	x
<div style="border: 1px solid black; padding: 5px; margin-bottom: 10px;"> Store c-Medium off >ON< </div>	x
<div style="border: 1px solid black; padding: 5px; margin-bottom: 10px;"> Store diagnostic off >ON< </div>	x
<div style="border: 1px solid black; padding: 5px;"> Beep on storage >ON< off </div>	x

		INIT-resistant
SYSTEM settings\serial transmis.		
SYSTEM settings↑ serial transmis.	selection of the displays for the formatting of the serial transmission of measured values	
SER:kill spaces off >ON<	activation of the serial transmission with/without blanks	x
SER:decimalpoint '.' >','<	selection of the decimal marker for floating point numbers	x
SER:col-separat. ';' >'TAB'<	selection of the character for column separation	x
SYSTEM settings\Miscellaneous		
SYSTEM settings↑ Miscellaneous	selection of the display for the setting of the contrast	
SETUP DISPLAY ← CONTRAST →	setting of the contrast of the display	
Instrum. Inform.		
Special Funct. ↑ Instrum. Inform.	selection of the displays for information about the transmitter	
F60X-XXXXXXXX Free 18327	display of the type, serial number and max. available data logger memory	x
F60X-XXXXXXXX V x.xx dd.mm.yy	display of the type, serial number and firmware version with the date (dd - day, mm - month, yy - year)	x

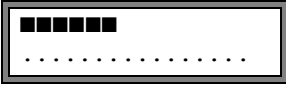
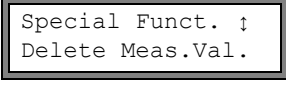
	INIT-resistant
<p>Store current set</p> <div data-bbox="113 240 398 323" style="border: 1px solid black; padding: 5px; margin-bottom: 10px;"> Special Funct. ↓ Store Curr.Rec. </div> <p>selection of the displays for the storing of a parameter record This menu item can only be selected if the parameters have been entered in the program branch <code>Parameter</code>.</p> <div data-bbox="113 408 398 491" style="border: 1px solid black; padding: 5px; margin-bottom: 10px;"> Store Par. To: ↓ Par.Record 01 </div> <p>selection of the number for a parameter record</p> <div data-bbox="113 517 398 600" style="border: 1px solid black; padding: 5px;"> Overwrite no >YES< </div> <p>confirmation of overwriting of an existing parameter record This display will only be indicated if the selected number already contains a parameter record.</p>	
<p>Delete Para.Rec.</p> <div data-bbox="113 735 398 818" style="border: 1px solid black; padding: 5px; margin-bottom: 10px;"> Special Funct. ↓ Delete Para.Rec. </div> <p>selection of the displays for the deleting of a parameter record</p> <div data-bbox="113 844 398 927" style="border: 1px solid black; padding: 5px; margin-bottom: 10px;"> Delete: ↓ Par.Record 01 </div> <p>selection of the number of the parameter record to be deleted This display will only be indicated if a parameter set already exists.</p> <div data-bbox="113 984 398 1067" style="border: 1px solid black; padding: 5px;"> Really Delete? no >YES< </div> <p>confirmation for the deleting of a parameter record</p>	
<p>Print Meas.Val.</p> <div data-bbox="113 1139 398 1222" style="border: 1px solid black; padding: 5px; margin-bottom: 10px;"> Special Funct. ↓ Print Meas.Val. </div> <p>selection of the displays for the transmission of stored measured values to a PC</p> <div data-bbox="113 1248 398 1331" style="border: 1px solid black; padding: 5px;"> Send Header 01 </div> <p>start of the transmission of measured values This display will only be indicated if the data logger contains measured values and the transmitter is connected to a PC via a serial cable.</p>	

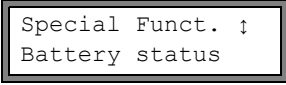
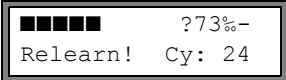
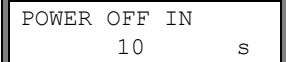
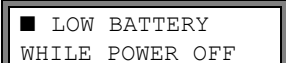
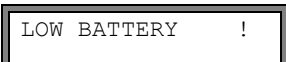
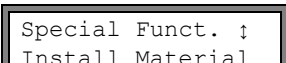
	INIT-resistant
	display of the data transmission progress
<p>Delete Meas.Val.</p>	
	selection of the displays for the deleting of stored measured values
	confirmation for the deleting of measured values
	This display will only be indicated if measured values are stored in the data logger.
<p>Battery status</p>	
	selection of the displays for the charging of the battery
	display of the charge state of the battery If RELEARN is displayed, a relearn cycle is recommended.
	message that the transmitter will be switched off soon
	message when the transmitter is switched on that the transmitter had been switched off automatically due to a low charge state
	message that the battery is almost empty
<p>Install Material</p>	
	selection of the displays for the input of the pipe and lining materials

	INIT-resistant
<p>Install Material with Special Funct.\SYSTEM settings\ Libraries\Extended Library = off</p> <div data-bbox="113 272 398 352" style="border: 1px solid black; padding: 5px; margin-bottom: 10px;"> Install Material >EDIT< delete </div> <p data-bbox="430 268 936 320">selection whether a user defined material is to be edited or deleted</p> <div data-bbox="113 379 398 459" style="border: 1px solid black; padding: 5px; margin-bottom: 10px;"> USER Material ↑ #01:--not used-- </div> <p data-bbox="430 375 801 400">selection of a user defined material</p> <div data-bbox="113 486 398 566" style="border: 1px solid black; padding: 5px; margin-bottom: 10px;"> EDIT TEXT (↑↓←→) USER Material 1 </div> <p data-bbox="430 481 922 507">input of a designation for the selected material</p> <div data-bbox="113 593 398 673" style="border: 1px solid black; padding: 5px; margin-bottom: 10px;"> c-Material 1590.0 m/s </div> <p data-bbox="430 588 852 651">input of the sound speed of the material range: 600...6553.5 m/s</p> <div data-bbox="113 700 398 780" style="border: 1px solid black; padding: 5px; margin-bottom: 10px;"> Roughness 0.4 mm </div> <p data-bbox="430 695 826 721">input of the roughness of the material</p> <p>Install Material with Special Funct.\SYSTEM settings\ Libraries\Extended Library = on</p> <div data-bbox="113 887 398 967" style="border: 1px solid black; padding: 5px; margin-bottom: 10px;"> Edit Material ↑ Basics:Y=m*X +n </div> <p data-bbox="430 882 936 962">selection of the function for the temperature and pressure dependence of the material parameters</p> <div data-bbox="113 1026 398 1106" style="border: 1px solid black; padding: 5px; margin-bottom: 10px;"> USER Material ↑ #01:--not used-- </div> <p data-bbox="430 1021 801 1046">selection of a user defined material</p> <div data-bbox="113 1133 398 1212" style="border: 1px solid black; padding: 5px; margin-bottom: 10px;"> USER Material 2 >EDIT< delete </div> <p data-bbox="430 1128 936 1182">selection whether the user defined material is to be edited or deleted</p> <p data-bbox="430 1193 936 1248">This display will only be indicated if the selected material already exists.</p> <div data-bbox="113 1313 398 1393" style="border: 1px solid black; padding: 5px; margin-bottom: 10px;"> #2: Input Name: USER MATERIAL 2 </div> <p data-bbox="430 1308 922 1334">input of a designation for the selected material</p>	

	INIT-resistant
<pre>T-SOUNDSP. 1500.0 m/s</pre>	<p>input of the constants for the transversal sound speed of the material</p> <p>The number of constants depends on the function selected above.</p>
<pre>L-SOUNDSP. 1500.0 m/s</pre>	<p>input of the constants for the longitudinal sound speed of the material</p> <p>The number of constants depends on the function selected above.</p>
<pre>Default soundsp. long. >TRANS.<</pre>	<p>selection of the sound wave type for the flow measurement</p>
<pre>Roughness 0.4 mm</pre>	<p>input of the roughness of the material</p>
<pre>Save changes no >YES<</pre>	<p>confirmation that the changes are to be saved</p> <p>This display will only be indicated if a new material has been entered or the parameters of an existing material have been changed.</p>
<p>Install Medium</p>	
<pre>Special Funct. ↑ Install Medium</pre>	<p>selection of the displays for the input of fluids</p>
<p>Install Medium With Special Funct.\SYSTEM settings Libraries\Extended Library = off</p>	
<pre>Install Medium >EDIT< delete</pre>	<p>selection whether a user defined fluid is to be edited or deleted</p>
<pre>USER Medium ↑ #01:--not used--</pre>	<p>selection of a user defined fluid</p>
<pre>EDIT TEXT (↑↓←→) USER Medium 1</pre>	<p>input of a designation for the selected fluid</p>
<pre>c-Medium 1500.0 m/s</pre>	<p>input of the average sound speed of the fluid range: 500.0...3500.0 m/s</p>

	INIT-resistant
<div style="border: 1px solid black; padding: 5px; width: fit-content;"> c-Medium=1500m/s range +/-150m/s </div>	input of the area around the average sound speed of the fluid range: 50...999 m/s
<div style="border: 1px solid black; padding: 5px; width: fit-content;"> Kinem.Viscosity 1.01 mm2/s </div>	input of the kinematic viscosity of the fluid range: 0.01...30 000.00 mm ² /s
<div style="border: 1px solid black; padding: 5px; width: fit-content;"> Density 1.00 g/cm3 </div>	input of the operating density of the fluid
<p>Install Medium with \Special Funct.\SYSTEM settings Libraries\Extended Library = on</p>	
<div style="border: 1px solid black; padding: 5px; width: fit-content;"> Edit Medium ↓ Basics:Y=m*X +n </div>	selection of the function for the temperature and pressure dependence of the fluid parameters
<div style="border: 1px solid black; padding: 5px; width: fit-content;"> USER Medium ↓ #01:--not used-- </div>	selection of a user defined fluid
<div style="border: 1px solid black; padding: 5px; width: fit-content;"> USER MEDIUM 2 >EDIT< delete </div>	selection whether the user defined fluid is to be edited or deleted This display will only be indicated if the selected fluid already exists.
<div style="border: 1px solid black; padding: 5px; width: fit-content;"> #2: Input Name: USER MEDIUM 2 </div>	input of a designation for the selected fluid
<div style="border: 1px solid black; padding: 5px; width: fit-content;"> SOUNDSPEED 1500.0 m/s </div>	input of the constants for the longitudinal sound speed of the fluid The number of constants depends on the function selected above.
<div style="border: 1px solid black; padding: 5px; width: fit-content;"> VISCOSITY 1.0 mm2/s </div>	input of the kinematic viscosity of the fluid
<div style="border: 1px solid black; padding: 5px; width: fit-content;"> DENSITY 1.0 g/cm3 </div>	input of the operating density of the fluid

	INIT-resistant
<div data-bbox="84 193 368 276" style="border: 1px solid black; padding: 5px; margin-bottom: 10px;"> Save changes no >YES< </div> <p data-bbox="398 188 904 308"> confirmation that the changes are to be saved This display will only be indicated if a new fluid has been entered or the parameters of an existing fluid have been changed. </p> <p data-bbox="84 328 468 355"> After the input of HotCode 071001 </p> <div data-bbox="84 383 368 466" style="border: 1px solid black; padding: 5px; margin-bottom: 10px;"> DNmin Q-Sensor 15 mm </div> <p data-bbox="398 378 904 467"> input of the lower limit of the inner pipe diameter for the displayed transducer type range: 3...63 mm </p>	x

B Units of Measurement

Length/roughness	
Unit of meas.	description
mm	millimeter

Temperature	
Unit of meas.	description
°C	degree Celsius

inch	inch
------	------

°F	degree Fahrenheit
----	-------------------

Pressure	
Unit of meas.	description
bar(a)	bar (absolute)
bar(g)	bar (relative)

psi(a)	pound per square inch (absolute)
psi(g)	pound per square inch (relative)

Density	
Unit of meas.	description
g/cm ³	gram per cubic centimeter
kg/cm ³	kilogram per cubic centimeter

Sound speed	
Unit of meas.	description
m/s	meter per second

Kinematic viscosity	
Unit of meas.	description
mm ² /s	square millimeter per second

1 mm²/s = 1 cSt

Flow velocity	
Unit of meas.	description
m/s	meter per second
cm/s	centimeter per second

in/s	inch per second
fps (ft/s)	foot per second

Volumetric flow rate		Volume (totalized)
Unit of meas.	description	Unit of meas.
m ³ /d	cubic meter per day	m ³
m ³ /h	cubic meter per hour	m ³
m ³ /min	cubic meter per minute	m ³
m ³ /s	cubic meter per second	m ³
km ³ /h	1000 cubic meters per hour	km ³
ml/min	milliliter per minute	l or m ³ *
l/h	liter per hour	l or m ³ *
l/min	liter per minute	l or m ³ *
l/s	liter per second	l or m ³ *
hl/h	hectoliter per hour	hl or m ³ *
hl/min	hectoliter per minute	hl or m ³ *
hl/s	hectoliter per second	hl or m ³ *
MI/d (Megalit/d)	megaliter per day	MI or m ³ *

bbl/d	barrel per day	bbl
bbl/h	barrel per hour	bbl
bbl/m	barrel per minute	bbl
USgpd (US-gal/d)	gallon per day	gal

Volumetric flow rate		Volume (totalized)
Unit of meas.	description	Unit of meas.
USgph (US-gal/h)	gallon per hour	gal
USgpm (US-gal/m)	gallon per minute	gal
USgps (US-gal/s)	gallon per second	gal
KGPM (US-Kgal/m)	kilogallon per minute	kgal
MGD (US-Mgal/d)	million gallons per day	Mg
CFD	cubic foot per day	cft**
CFH	cubic foot per hour	cft
CFM	cubic foot per minute	cft
CFS	cubic foot per second	aft***
MMCFD	million cubic feet per day	MMCF
MMCFH	million cubic feet per hour	MMCF

* Selection with HotCode 007027, firmware version V5.91 or higher
 ** cft: cubic foot
 *** aft: acre foot
 1 US-gal = 3.78541 l
 1 bbl = 42 US-gal = 158.9873 l

Mass flow rate		Mass (totalized)
Unit of meas.	description	Unit of meas.
t/h	metric ton per hour	t
t/d	metric ton per day	t
kg/h	kilogram per hour	kg
kg/min	kilogram per minute	kg
kg/s	kilogram per second	kg
g/s	gram per second	g

lb/d	pound per day	lb
lb/h	pound per hour	lb

Mass flow rate		Mass (totalized)
Unit of meas.	description	Unit of meas.
lb/m	pound per minute	lb
lb/s	pound per second	lb
klb/h	kilopound per hour	klb
klb/m	kilopound per minute	klb

1 lb = 453.59237 g
 1 t = 1000 kg

Heat flow rate		Heat quantity (totalized)
Unit of meas.	description	Unit of meas.
W	Watt	Wh or J*
kW	kilowatt	kWh or kJ*
MW	megawatt	MWh or MJ*
GW	gigawatt	GWh or GJ*

kBTU/minute	kBTU per minute	kBT
kBTU/hour	kBTU per hour	kBT
MBTU/hour	MBTU per hour	MBT
MBTU/day	MBTU per day	MBT
TON (TH)	TON, totals in TONhours	TH
TON (TD)	TON, totals in TONdays	TD
kTON (kTH)	kTON, totals in TONhours	kTH
kTON (kTD)	kTON, totals in TONdays	kTD

BTU: British Thermal Unit
 1 W = 1 J/s = (1/1055.05585262) BTU/s

TON: ton of refrigeration
 1 W = 1 J/s = (1/3516.852842) TON
 1 TON = 200 BTU/min

*Selection in Special function\SYSTEM settings\Measurement

Flow Nomogram (metrical)

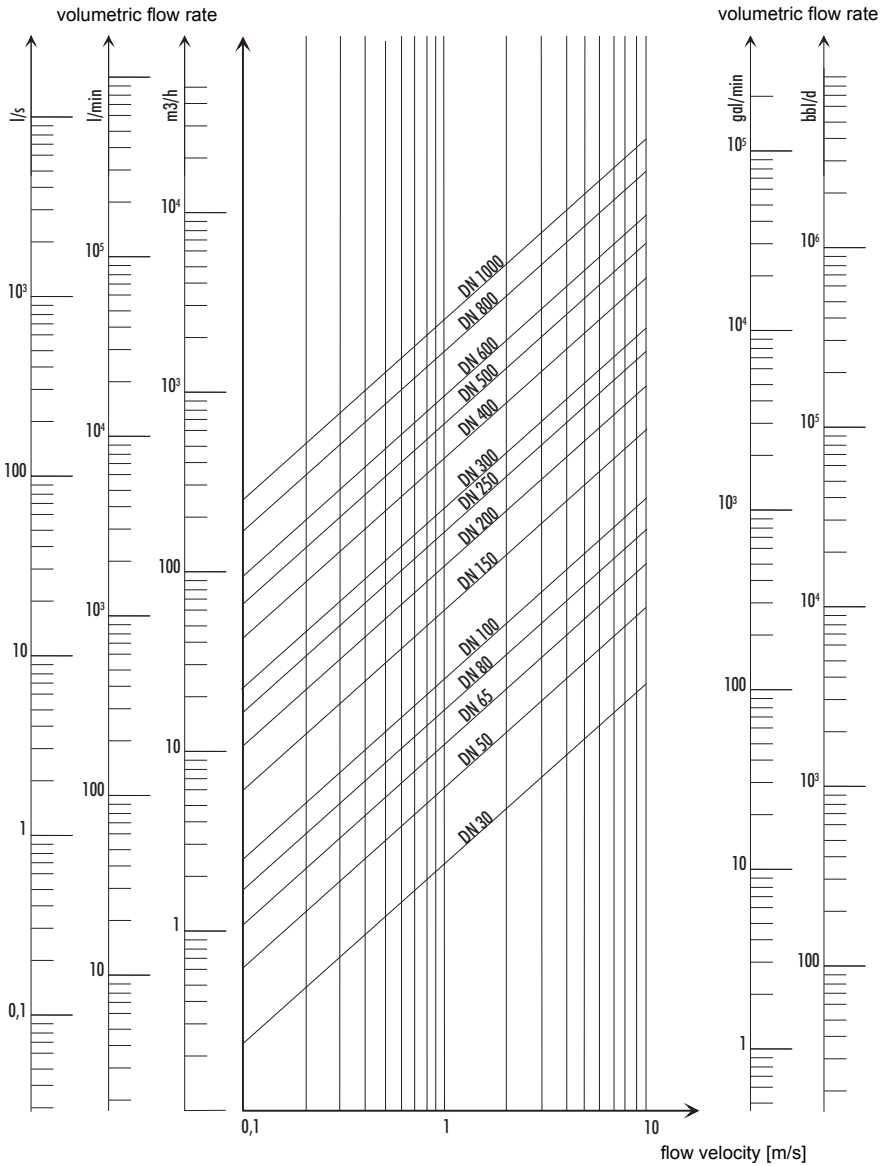

Flow Nomogram (imperial)

volumetric flow rate

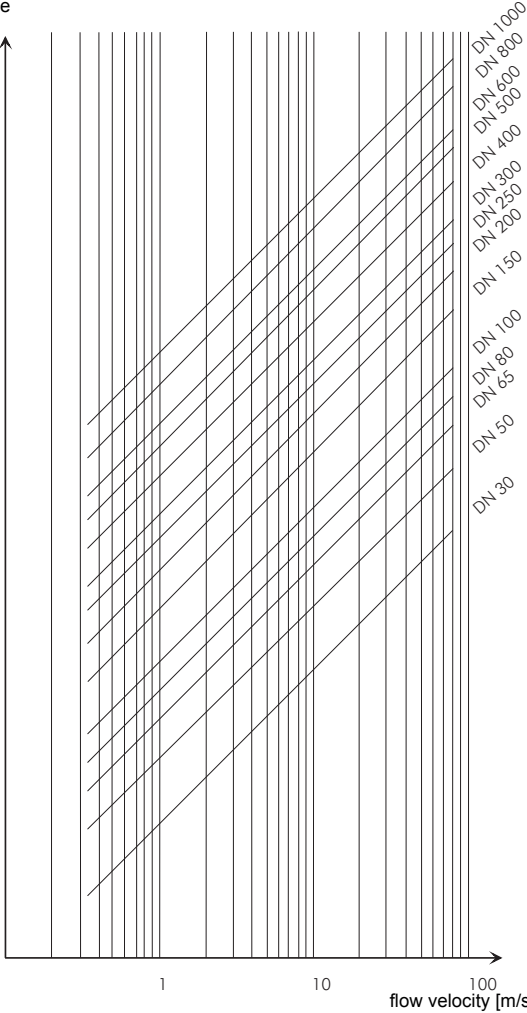
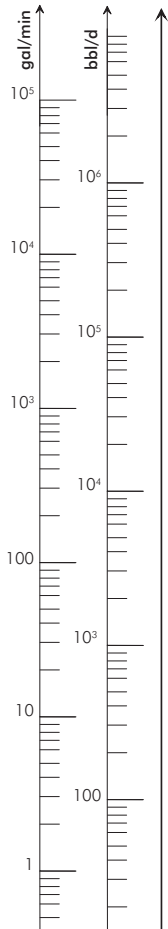

volumetric flow rate

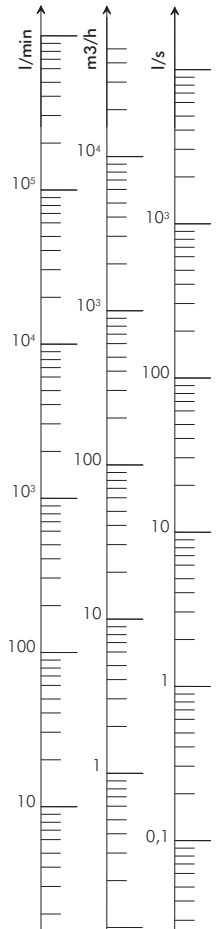

C Reference

The following tables provide assistance for the user. The accuracy of the data depends on the composition, temperature and processing of the material. FLEXIM does not assume liability for any inaccuracies.

C.1 Sound Speed of Selected Pipe and Lining Materials at 20 °C

The values of some of these materials are stored in the internal database of the transmitter. Column c_{flow} shows the sound speed (longitudinal or transversal) used for the flow measurement.

material	c_{trans} [m/s]	c_{long} [m/s]	c_{flow}	material	c_{trans} [m/s]	c_{long} [m/s]	c_{flow}
steel (normal)	3 230	5 930	trans	bitumen	2 500	-	trans
stainless steel	3 100	5 790	trans	Acrylic	1 250	2 730	long
DUPLEX	3 272	5 720	trans	Lead	700	2 200	long
ductile iron	2 650	-	trans	Cu-Ni-Fe	2 510	4 900	trans
asbestos cement	2 200	-	trans	cast iron	2 200	4 600	trans
titanium	3 067	5 955	trans	rubber	1 900	2 400	trans
copper	2 260	4 700	trans	glass	3 400	5 600	trans
aluminum	3 100	6 300	trans	PFA	500	1 185	long
brass	2 100	4 300	trans	PVDF	760	2 050	long
plastic	1 120	2 000	long	Sintimid	-	2 472	long
GRP	-	2 650	long	Teka PEEK	-	2 534	long
PVC	-	2 395	long	Tekason	-	2 230	long
PE	540	1 950	long				
PP	2 600	2 550	trans				

The sound speed depends on the composition and the manufacturing process of the material. The sound speed of alloys and cast materials fluctuates strongly. The values only serve as an orientation.

C.2 Typical Roughnesses of Pipes

The values are based on experience and measurements.

material	absolute roughness [mm]
drawn pipes of non-ferrous metal, glass, plastics and light metal	0...0.0015
drawn steel pipes	0.01...0.05
fine-planed, polished surface	max. 0.01
planed surface	0.01...0.04
rough-planed surface	0.05...0.1
welded steel pipes, new	0.05...0.1
after long use, cleaned	0.15...0.2
moderately rusted, slightly encrusted	max. 0.4
heavily encrusted	max. 3
cast iron pipes:	
bitumen lining	> 0.12
new, without lining	0.25...1
rusted	1...1.5
encrusted	1.5...3

C.3 Typical Properties of Selected Fluids at 20 °C and 1 bar

fluid	sound speed [m/s]	kinematic viscosity [mm ² /s]	density [g/cm ³]
acetone	1 190	0.4	0.7300
ammonia (NH ₃)	1 386	0.2	0.6130
gasoline	1 295	0.7	0.8800
beer	1 482	1.0	0.9980
BP Transcal LT	1 365	20.1	0.8760
BP Transcal N	1 365	94.3	0.8760
diesel	1 210	7.1	0.8260
ethanol	1 402	1.5	0.7950
hydrofluoric acid 50 %	1 221	1.0	0.9980
hydrofluoric acid 80 %	777	1.0	0.9980
glycol	1 665	18.6	1.1100
20 % glycol/H ₂ O	1 655	1.7	1.0280
30 % glycol/H ₂ O	1 672	2.2	1.0440
40 % glycol/H ₂ O	1 688	3.3	1.0600
50 % glycol/H ₂ O	1 705	4.1	1.0750
ISO VG 100	1 487	314.2	0.8690
ISO VG 150	1 487	539.0	0.8690
ISO VG 22	1 487	50.2	0.8690
ISO VG 220	1 487	811.1	0.8690
ISO VG 32	1 487	78.0	0.8690
ISO VG 46	1 487	126.7	0.8730
ISO VG 68	1 487	201.8	0.8750
methanol	1 119	0.7	0.7930
milk	1 482	5.0	1.0000
Mobiltherm 594	1 365	7.5	0.8730

fluid	sound speed [m/s]	kinematic viscosity [mm²/s]	density [g/cm³]
Mobiltherm 603	1 365	55.2	0.8590
NaOH 10 %	1 762	2.5	1.1140
NaOH 20 %	2 061	4.5	1.2230
Paraffin 248	1 468	195.1	0.8450
R134 Freon	522	0.2	1.2400
R22 Freon	558	0.1	1.2130
crude oil, light	1 163	14.0	0.8130
crude oil, heavy	1 370	639.5	0.9220
sulphuric acid 30 %	1 526	1.4	1.1770
sulphuric acid 80 %	1 538	13.0	1.7950
sulphuric acid 96 %	1 366	11.5	1.8350
juice	1 482	1.0	0.9980
hydrochloric acid 25 %	1 504	1.0	1.1180
hydrochloric acid 37 %	1 511	1.0	1.1880
seawater	1 522	1.0	1.0240
Shell Thermina B	1 365	89.3	0.8630
silicon oil	1 019	14 746.6	0.9660
SKYDROL 500-B4	1 387	21.9	1.0570
SKYDROL 500-LD4	1 387	21.9	1.0570
water	1 482	1.0	0.9990

C.4 Properties of Water at 1 bar and at Saturation Pressure

fluid temperature [°C]	fluid pressure [bar]	sound speed [m/s]	density	specific heat capacity*
0.1	1,013	1402.9	999.8	4,219
10	1,013	1447.3	999.7	4,195
20	1,013	1482.3	998.2	4,184
30	1,013	1509.2	995.6	4,180
40	1,013	1528.9	992.2	4,179
50	1,013	1542.6	988.0	4,181
60	1,013	1551.0	983.2	4,185
70	1,013	1554.7	977.8	4,190
80	1,013	1554.4	971.8	4,197
90	1,013	1550.5	965.3	4,205
100	1,013	1543.2	958.3	4,216
120	1,985	1519.9	943.1	4,244
140	3,615	1486.2	926.1	4,283
160	6,182	1443.2	907.4	4,335
180	10.03	1391.7	887.0	4,405
200	15.55	1332.1	864.7	4,496
220	23.20	1264.5	840.2	4,615
240	33.47	1189.0	813.4	4,772
260	46.92	1105.3	783.6	4,986
280	64.17	1012.6	750.3	5,289
300	85.88	909.40	712.1	5,750
320	112.8	793.16	667.1	6,537
340	146.0	658.27	610.7	8,208
360	186.7	479.74	527.6	15.00
373,946	220,640	72,356	322.0	∞

* at constant pressure

D Conformity Declarations

We,

FLEXIM Flexible Industriemesstechnik GmbH
 Wolfener Str. 36
 12681 Berlin
 Germany,



declare under our sole responsibility that the transmitter

FLUXUS *601,

to which this declaration relates, is in conformity with the following EC directives:

- EMC Directive 2004/108/EC for Electromagnetic Compatibility
- Low Voltage Directive 2006/95/EC for Electrical Safety

The transmitter is in conformity with the following European standards when used with the FLEXIM transducers and accessories:

EC Directive	Class	Standard	Description
EMC Directive	EMC Requirement	EN 61326-1:2013	Electrical equipment for measurement, control and laboratory use - EMC requirements - General requirements
	- Immunity	EN 61326-1:2013	Electrical equipment for continuous, unattended operation
		EN 61000-4-2:2009	Electromagnetic compatibility (EMC) - Testing and measurement techniques - Electrostatic discharge immunity test
		EN 61000-4-3:2006 + A1:2008 + A2:2010	Electromagnetic compatibility (EMC) - Testing and measurement techniques - Radiated, radio-frequency, electromagnetic field immunity test
		EN 61000-4-4:2004 + A1:2010	Electromagnetic compatibility (EMC) - Testing and measurement techniques - Electrical fast transient/burst immunity test
		EN 61000-4-5:2006	Electromagnetic compatibility (EMC) - Testing and measurement techniques - Surge immunity test
		EN 61000-4-6:2009	Electromagnetic compatibility (EMC) - Testing and measurement techniques - Immunity to conducted disturbances, induced by radio-frequency fields
	- Emission	EN 61326-1:2013	Electrical equipment class A
		EN 55011:2009 + A1:2010	Industrial, scientific and medical equipment - Radio-frequency disturbance characteristics - Limits and methods of measurement

(continuation on verso)

EC Directive	Class	Standard	Description
Low Voltage Directive	Equipment Safety Requirement	EN 61010-1:2010	Safety requirements for electrical equipment for measurement, control, and laboratory use - General requirements
		EN 61010-2-030:2010	Safety requirements for electrical equipment for measurement, control, and laboratory use - Particular requirements for testing and measuring circuits

The installation, operating and safety instructions have to be observed!

Berlin, 2015-06-01



Dipl.-Ing. Jens Hilpert
Managing Director