

INCLINEO[®]

The high precision inclinometer
ideal for flatness and angle measurement

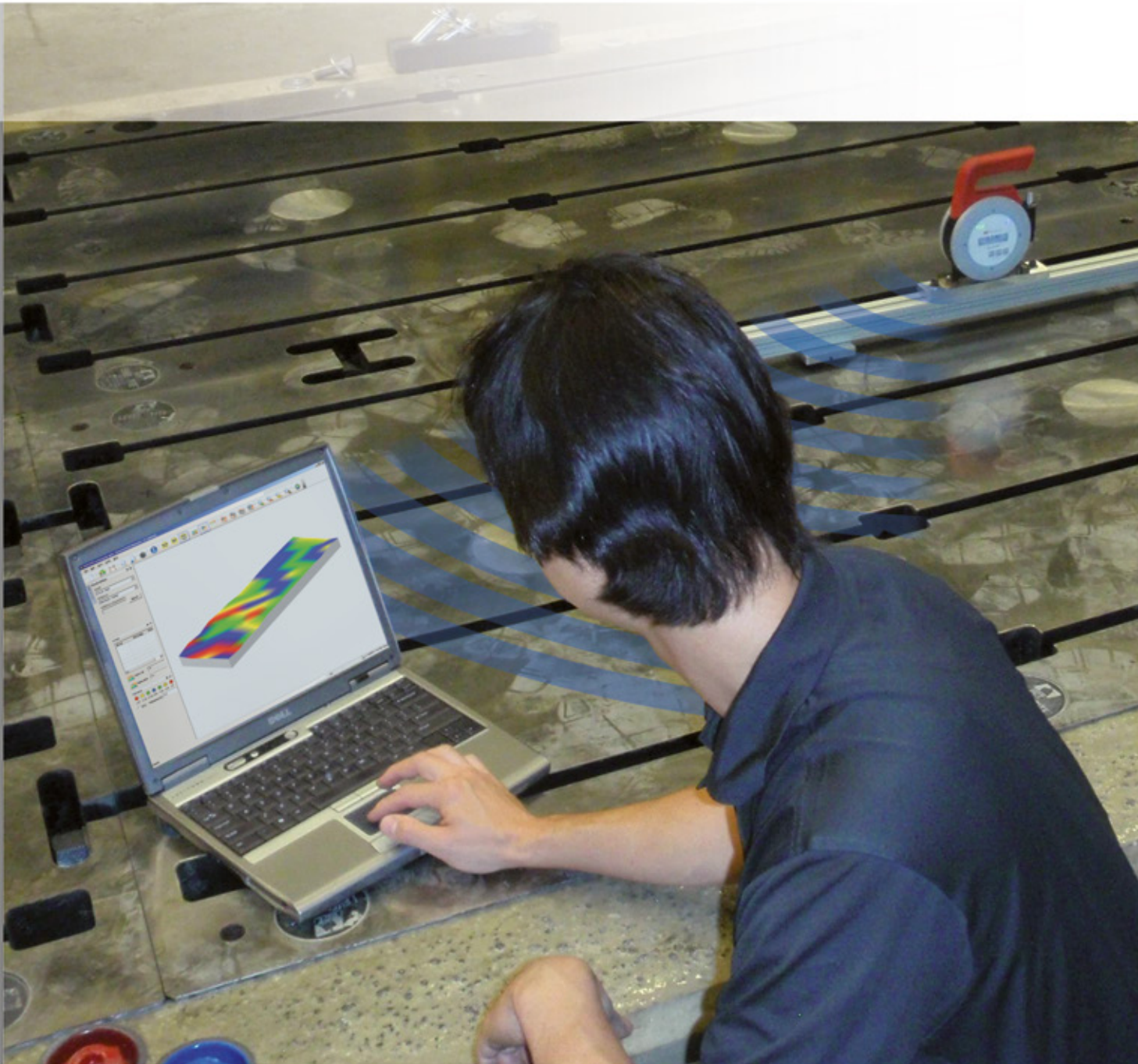

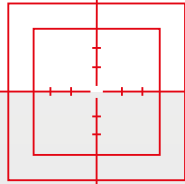

Advanced Measuring capabilities

Thanks to an innovative design that permits the housing to be rotated through 360°, INCLINEO® is readily adjustable to measure surfaces of any inclination.

INCLINEO® can be used as a stand-alone or in combination with the ALIGNMENT CENTER PC software to accomplish a wide range of measurement tasks

Different measurement setups are provided:

- ▶ absolute – measurement with respect to gravity
- ▶ relative – measurement with respect to a reference position



Angles



Flatness



Height



Straightness



Any inclination



Parallelism



Levelness



Plumbness

Bracketing solutions

Whether the surface is level or steep, be it shafts or rolls, with or without large gaps, PRÜFTECHNIK provides the right bracketing for a variety of applications.

INCLINEO® standard base options



Grooved mounting base for smooth surface



Prism-shaped mounting base for rolls and shafts

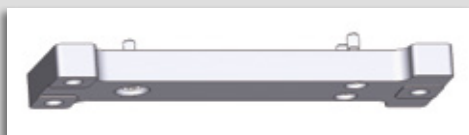

Three-point base for customised mountings

Advantages at a glance

- ▶ High precision electronic inclinometer for measurement of absolute or relative angles
- ▶ Rotatable housing allows measurement on surfaces with any inclination
- ▶ Outer ring with 30° marks and 5° scale on housing with integrated fine adjustment screw
- ▶ Appropriate bracketing for different applications
- ▶ Powerful Windows® based PC software
- ▶ Wireless PC communication
- ▶ Ideal for installation and service



High precision for advanced applications

Surface flatness

Used in combination with the ALIGNMENT CENTER PC software, INCLINEO® measures surface flatness of engine blocks, compressor frames or machine bases quickly and easily

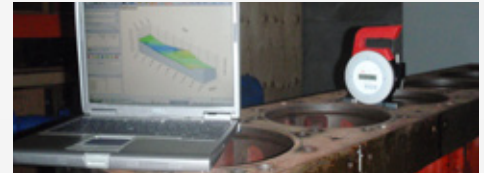

Foundation levelness

The INCLINEO® absolute measurement is used to determine foundation levelness



Straightness and parallelism

Straightness is measured by taking points along a line. The "Group" function within the software enables the evaluation of parallelism of the rails



Machine tools

The instrument's high precision makes it ideal for measuring machine geometries, especially for quality control.



Shaft plumbness

In calculating shaft plumbness, INCLINEO® compares two measurements taken at opposite shaft positions. Depending on the application, this is done by either rotating the shaft or positioning INCLINEO® at the two opposite sides.



Extend range base

The extend range base makes it possible to measure over large gaps. Its offset adjustment makes it suitable for a variety of application lengths.

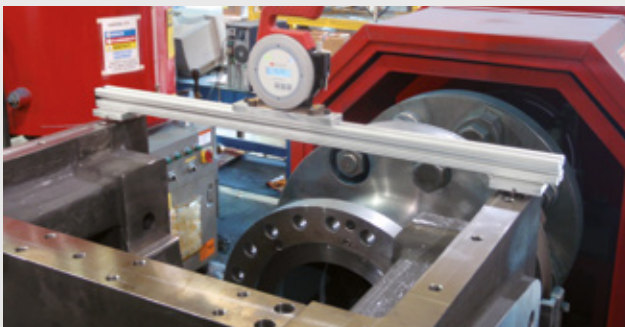

Magnetic foot

The magnetic foot is designed to provide maximum stability even on steep surfaces. Its construction ensures that parallelism to shaft or roll axis is maintained.

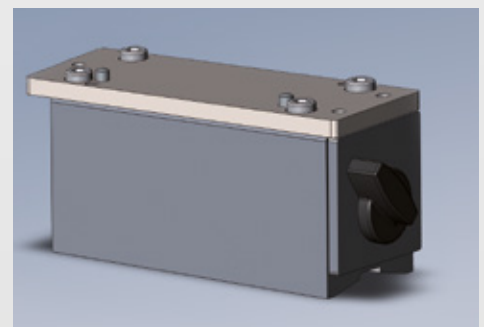

Powerful PC software

The ALIGNMENT CENTER software supports two-way communication between INCLINEO® and a PC. Measurement points are gathered by simply clicking the 'Take point' button on the PC software. Depending on the application, the inclination values are used to calculate height for both straightness and flatness measurements.

ALIGNMENT CENTER provides numerous functions for e.g. comparing surfaces, evaluating parallelism or splice more measurements together.

INCLINEO® technical data		
Measurement range	±10°	
Resolution	0.0003° [1"]	
Limits of error at calibration [Ta =22°C]	0.005% full scale 0.03% read out	
Limits of error at measurement [Ta =22°C]	Until 6 months after calibration	Until 12 months after calibration
	0.005% full scale 0.06% read out	0.005% full scale 0.12% read out
8-hour zero-point drift	0.04% full scale	
Digital Filter/Average	3rd order with 0.3 / 1 / 3 Hz options	
Temperature range	Storage: -40°C to 85°C Operation: -10°C to 60°C	
Display	LCD display, 132 x 32 pixel with LED backlight	
User interface	Three key operation	
Wireless communication	Embedded RF module with LED indicator	
External interface	RS-232 (serial) for computer and sensor; Connector for dial gauge	
Power supply	2 AA batteries	
Battery status indicator	3 LEDs	
Data storage	up to 999 measurements	

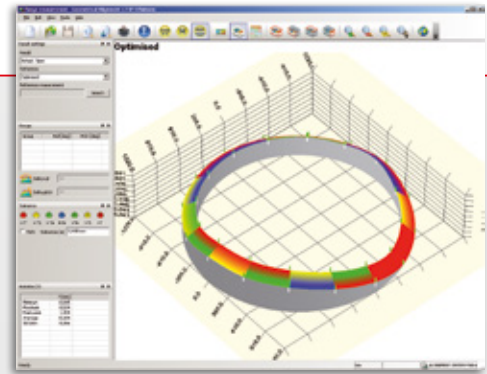

Flatness and levelness of circular or rectangular objects

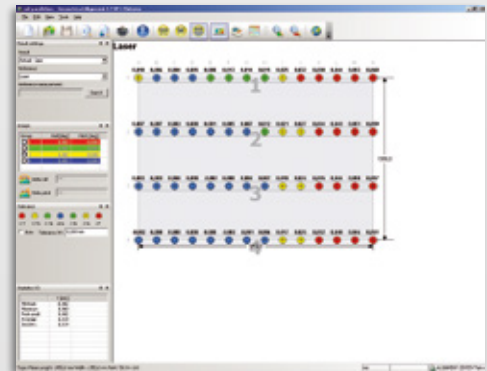

Straightness and parallelism of rails

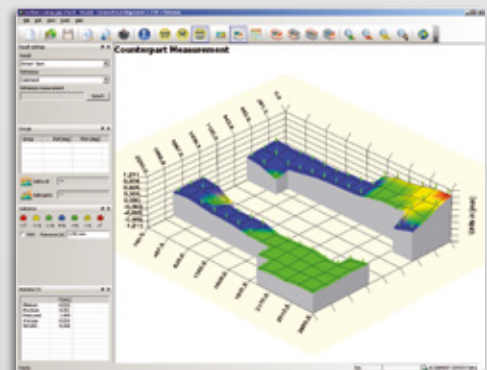

Parallelism of complex surfaces

INCLINEO® is a registered trademark of PRÜFTECHNIK Dieter Busch AG. No copying or reproduction of this information, in any form whatsoever, may be undertaken without express written permission of PRÜFTECHNIK Alignment Systems GmbH. The information contained in this leaflet is subject to change without further notice due to the PRÜFTECHNIK policy of continuous product development. PRÜFTECHNIK products are subject to patents granted or pending throughout the world. ISO 9001:2008 certified. © Copyright 2013 by PRÜFTECHNIK AG.



PRÜFTECHNIK
Alignment Systems GmbH
Freisinger Str.34
85737 Ismaning, Germany
Tel.: +49 89 99616-0
Fax: +49 89 99616-100
info@pruftechnik.com
www.pruftechnik.com

A member of the PRÜFTECHNIK group